

DIGITAL PIANO

Owner's Manual

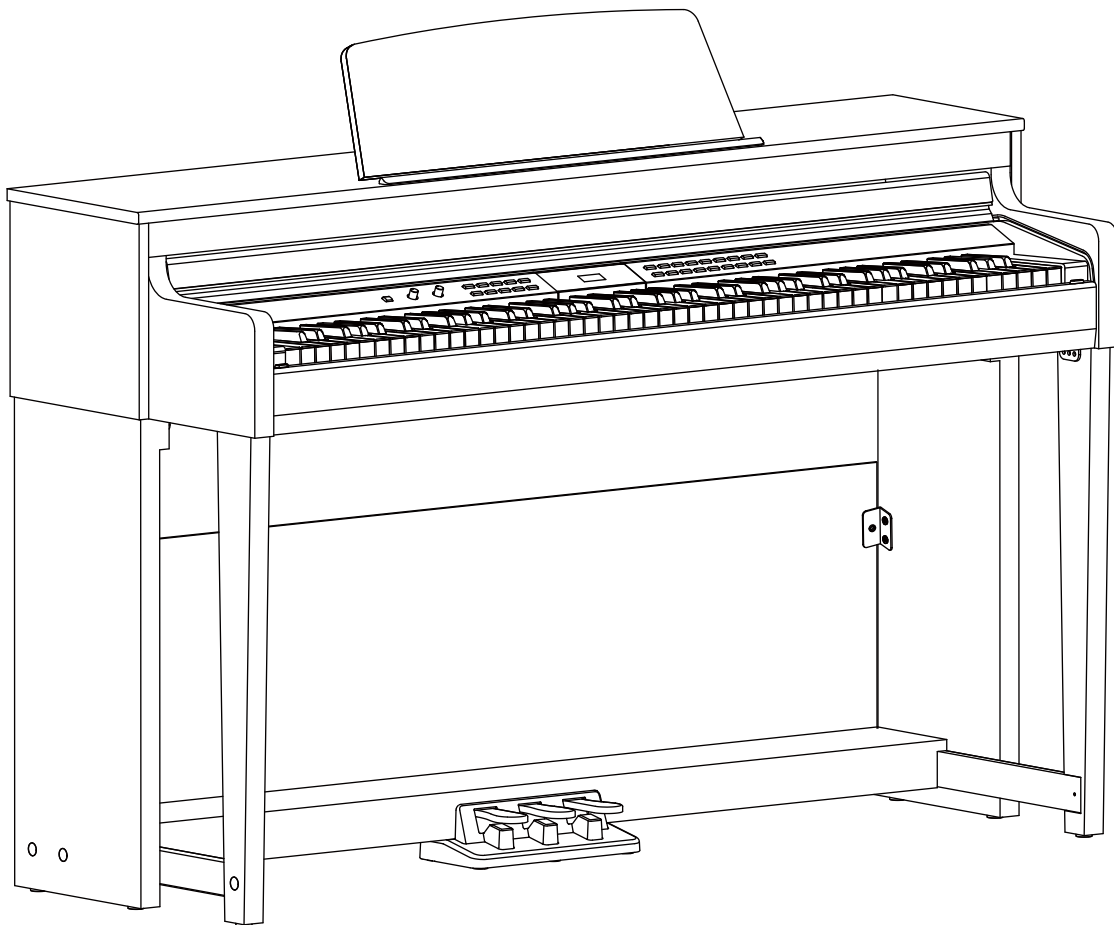

INFORMATION FOR YOUR SAFETY!

THE FCC REGULATION WARNING (for USA)

This equipment has been tested and found to comply with the limits for a Class B digital device, pursuant to Part 15 of the FCC Rules.

These limits are designed to provide reasonable protection against harmful interference in a residential installation. This equipment generates, uses, and can radiate radio frequency energy and, if not installed and used in accordance with the instructions, may cause harmful interference to radio communications. However, there is no guarantee that interference will not occur in a particular installation. If this equipment does cause harmful interference to radio or television reception, which can be determined by turning the equipment off and on, the user is encouraged to try to correct the interference by one or more of the following measures:

- Reorient or relocate the receiving antenna.
- Increase the separation between the equipment and receiver.
- Connect the equipment into an outlet on a circuit different from that to which the receiver is connected.
- Consult the dealer or an experienced radio/TV technician for help.

Unauthorized changes or modification to this system can void the user's authority to operate this equipment.

CAUTION

The normal function of the product may be disturbed by Strong Electro Magnetic Interference. If so, simply reset the product to resume normal operation by following the owner's manual. In case the function could not resume, please use the product in other location.

PRECAUTIONS

PLEASE READ CAREFULLY BEFORE PROCEEDING

Please keep this manual in a safe place for future reference.

Power Supply

Please connect the designated AC adaptor to an AC outlet of the correct voltage.

Do not connect it to an AC outlet of voltage other than that for which your instrument is intended.

Unplug the AC power adaptor when not using the instrument, or during electrical storms.

Connections

Before connecting the instrument to other devices, turn off the power to all units. This will help prevent malfunction and / or damage to other devices.

Location

Do not expose the instrument to the following conditions to avoid deformation, discoloration, or more serious damage:

- Direct sunlight
- Extreme temperature or humidity
- Excessive dusty or dirty location
- Strong vibrations or shocks
- Close to magnetic fields

Interference with other electrical devices

Radios and televisions placed nearby may experience reception interference. Operate this unit at a suitable distance from radios and televisions.

Cleaning

Clean only with a soft, dry cloth.

Do not use paint thinners, solvents, cleaning fluids, or chemical-impregnated wiping cloths.

Handling

Do not apply excessive force to the switches or controls.

Do not let paper, metallic, or other objects into the instrument. If this happens, remove the electric plug from the outlet. Then have the instrument inspected by qualified service personnel.

Disconnect all cables before moving the instrument.

Panel & Display Description

Front Panel.....	4
Rear Panel.....	4
Pedal.....	4

Setup

Setup Guide.....	6
------------------	---

Connections

Connecting a Pair of Headphones.....	9
Connecting an Audio Equipment.....	9
Connecting an MP3/CD Player.....	9
Connecting a Computer or a MIDI Device.....	9

Quick Start

Power Supply.....	10
Adjusting the Master Volume.....	10
Adjusting the Voice Brilliance.....	10
Playing the Demo Songs.....	10
Playing the Voices.....	11
Playing the Styles.....	11
Playing the Songs.....	11
Recording.....	12

Advanced Use

Playing the Voices.....	13
Playing a Voice.....	13
Playing Two Voices Simultaneously - Dual.....	13
Playing Different Voices with Both Hands - Lower.....	13
Playing Voice Demo.....	14
Touch Sensitivity.....	14
Transpose.....	15
Tune.....	15
Pedal Resonance.....	15
Metronome.....	16

Auto Accompaniment

Selecting a Style.....	17
Playing the Style.....	17

Fill In A/B.....	17
Accompaniment Volume.....	17
Tempo.....	18

DSP Effect

Reverb.....	19
Chorus.....	19
EQ.....	19

Song

Listening to the Songs.....	20
Practise the Songs.....	20

Song Recording

Prepare Recording.....	20
Start Recording.....	21
Stop Recording.....	21
Play a User Song.....	21
Delete a User Song.....	21

Duet.....	22
-----------	----

Twinoa.....	23
-------------	----

Beep Tone.....	23
----------------	----

MIDI

What's MIDI?.....	24
-------------------	----

Troubleshooting.....	25
----------------------	----

Specifications.....	25
---------------------	----

Appendices

Voice List.....	26
Style List.....	27
Song List.....	28
Demo List.....	29
MIDI Implementation Chart.....	30

Panel Description

Front Panel

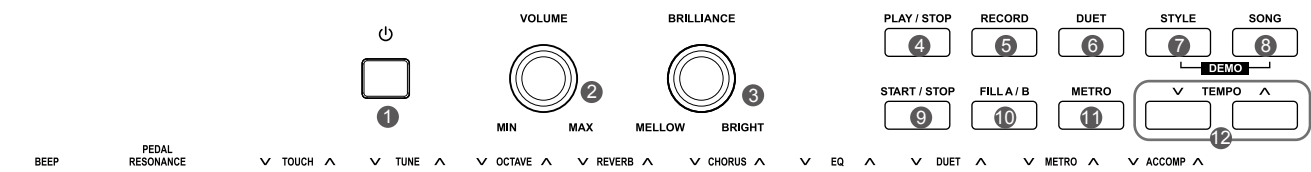

1. [POWER] Switch

Turn the power on or off.

2. [VOLUME] Knob

Adjust the master volume.

3. [BRILLIANCE] Knob

Adjust the voice brilliance.

4. [PLAY/STOP] Button

Start or stop playing a recorded song.

5. [RECORD] Button

Enter the recording mode.

6. [DUET] Button

Turn the duet function on or off.

7. [STYLE] Button

Enter the style mode.

8. [SONG] Button

Enter the song mode.
Press both [STYLE] and [SONG] buttons simultaneously to enter the demo mode.

9. [START/STOP] Button

Start or stop playing a song or a style.

10. [FILL A/B] Button

Play the fill-in pattern A or B.

11. [METRO] Button

Turn the metronome on or off.

12. [TEMPO +/-] Button

Adjust the current tempo.

Rear Panel

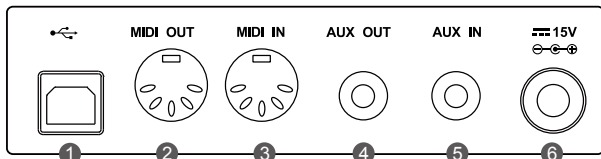

1. USB Jack

Connect to a computer.

2. MIDI OUT Jack

Transmit MIDI messages to an external MIDI device.

3. MIDI IN Jack

Receive MIDI messages from an external MIDI device.

4. AUX OUT Jack

Connect external audio equipment.

5. AUX IN Jack

Connect an external audio source, such as an MP3 or CD player.

6. DC IN Jack

Connect the DC power adaptor.

Pedal

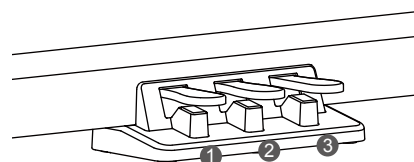

1. Soft Pedal

When you step on the soft pedal, all notes played on the keyboard will have a softer effect.

2. Sostenuto Pedal

When you step on the sostenuto pedal, the notes played before you step on the pedal will have a sustain effect.

3. Sustain Pedal

When you step on the sustain pedal, all notes played on the keyboard will have a longer sustain. It also supports the half-pedal operation. Performing with the sustain pedal will achieve a smooth effect.

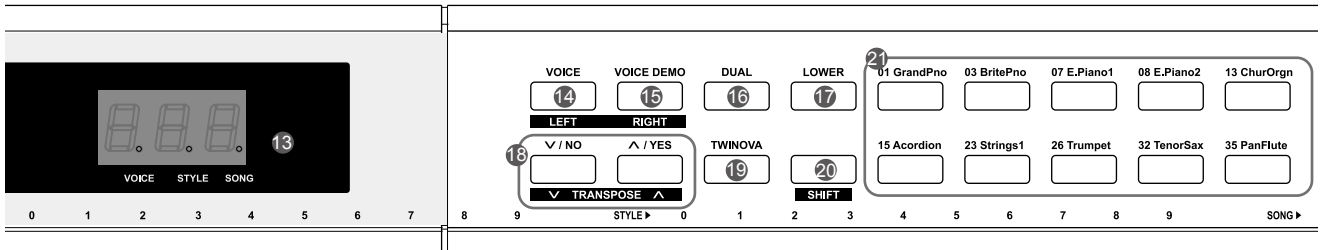

13. DISPLAY

Display all parameters and values related to the current operation.

17. [LOWER] Button

Turn the lower function on or off.

19. [TWINOVA] Button

Turn the twinova function on or off.

20. [SHIFT] Button

Press and hold it to access secondary functions of other buttons.

21. VOICE Select Buttons

Select a preset voice directly.

When [SHIFT] is released:

14. [VOICE] Button

Enter the voice mode.

15. [VOICE DEMO] Button

Start or stop the voice demo.

16. [DUAL] Button

Turn the dual function on or off.

18. [+YES] / [-NO] Button

Adjust the value.

When [SHIFT] is pressed:

14. [LEFT] Button

Turn on or off the left hand melody of the current song, so as to practise the left hand part.

15. [RIGHT] Button

Turn on or off the right hand melody of the current song, so as to practise the right hand part.

18. [TRANPOSE +/-] Button

Adjust the transpose value.

When [SHIFT] is pressed:

22. [BEEP] Key

Turn the beep tone on or off.

23. [PEDAL RESONANCE] Key

Turn the pedal resonance on or off.

24. [TOUCH] Keys

Set the touch level.

25. [TUNE] Keys

Adjust the tune value.

26. [OCTAVE] Keys

In TWINOVA mode, adjust the octave value.

27. [REVERB] Keys

Set the reverb type.

28. [CHORUS] Keys

Set the chorus type.

29. [EQ] Keys

Set the EQ type.

30. [DUET] Keys

Set the duet type.

31. [METRO] Keys

Set the metronome type.

32. [ACCOMP] Keys

Adjust the accompaniment volume.

33. [TEMPO] Keys

Tap to set the tempo.

34. [STYLE] Keys

Select the desired style.

35. [SONG] Keys

Select the desired song.

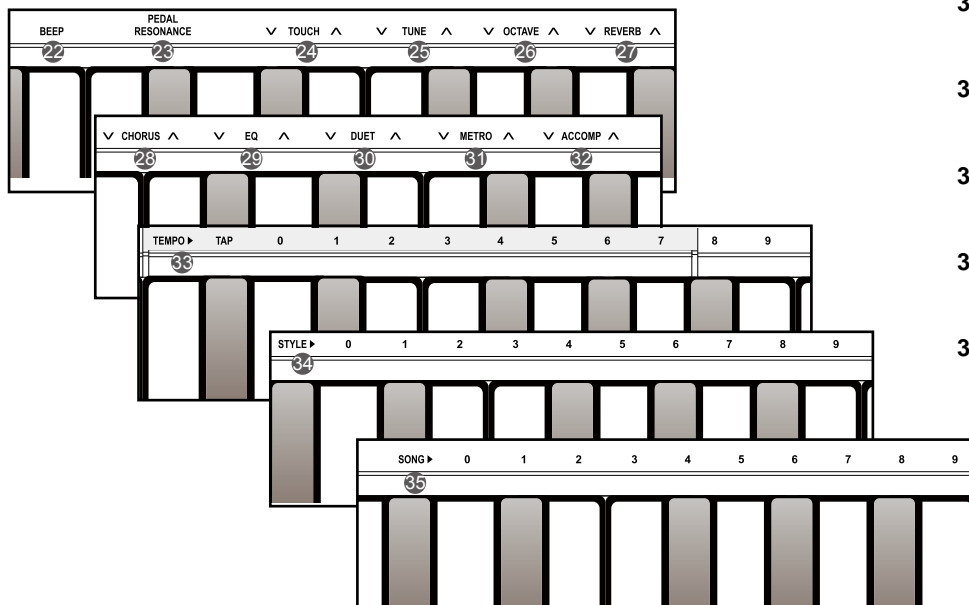

Setup

This section contains information about setting up your instrument and preparing to play. Please go through this section carefully before turning the power on.

Setup Guide

Before proceeding to assemble the stand, please get a Philip's screwdriver (not supplied).

Make sure you have the following parts in the package.

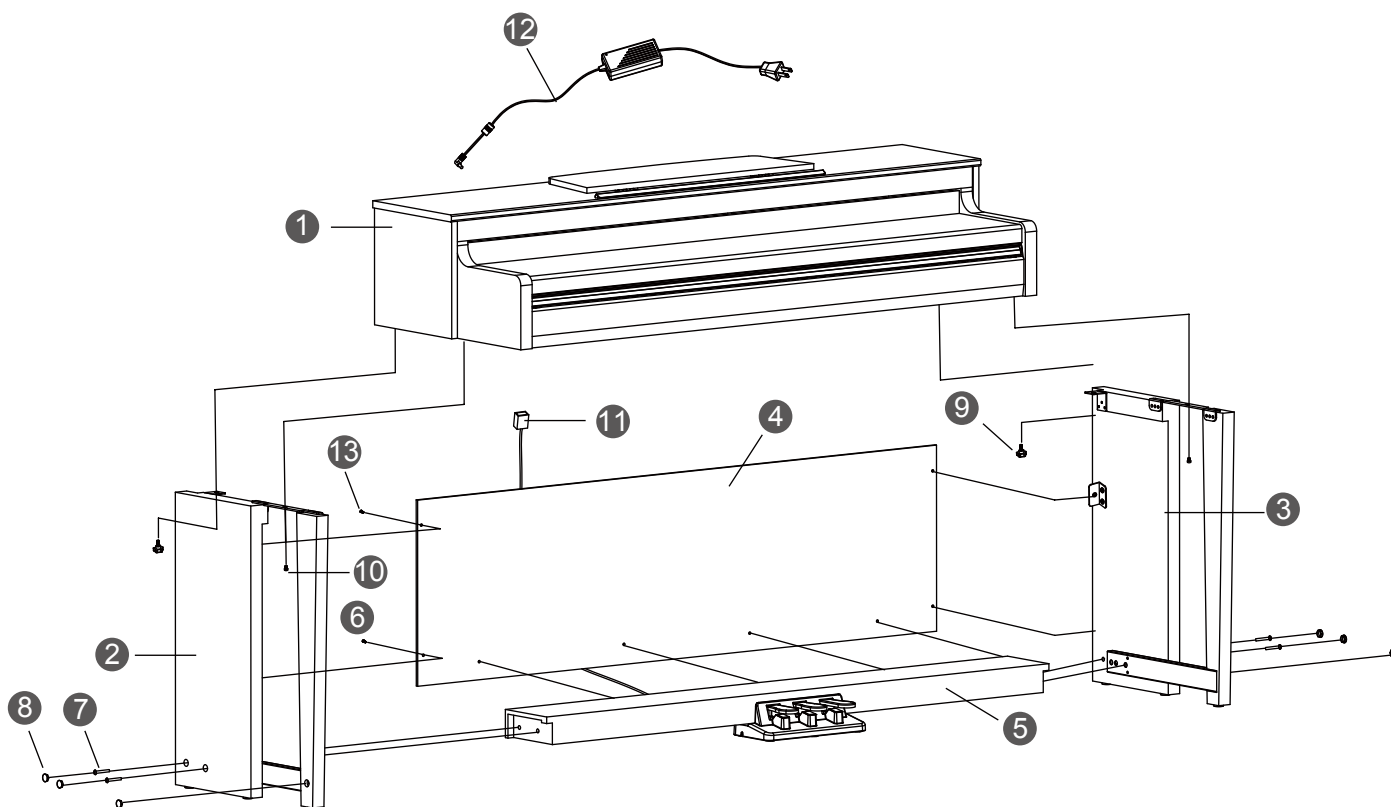

1.	Piano body
2.	Left stand component
3.	Right stand component
4.	Back board
5.	Pedal box
6.	Screws 4x15BA (4PCS)
7.	Screws M6x50 (4PCS)
8.	Screw caps (6PCS)
9.	Hand screws (2PCS)
10.	Screws M6x18 (2PCS)
11.	Pedal cable
12.	AC power adaptor
13.	Screws M6x12 (2PCS)

- A. Put the pedal box in between the left and right stand components, use 4 pieces of screws to stable the left and right stands on to pedal unit, and covered by 6 pieces of screw caps.

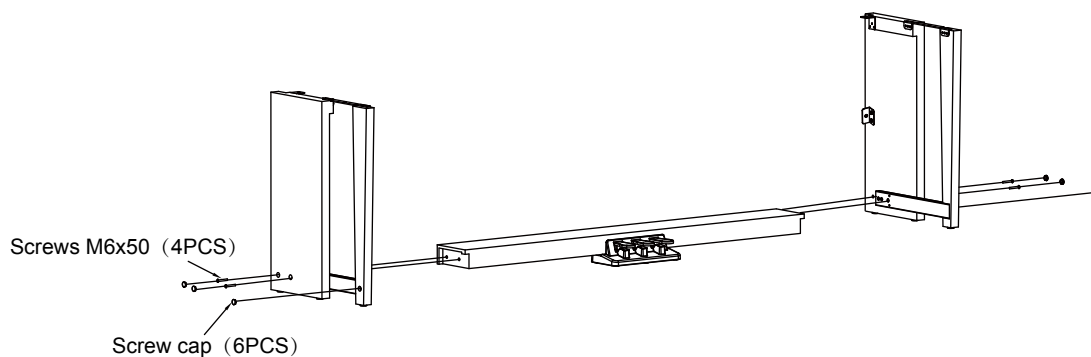

- B. Use 4 pieces of screws 4x15 BA & 2 pieces of screws M6x12, make back board fixed on the pedal box, left and right stand component.

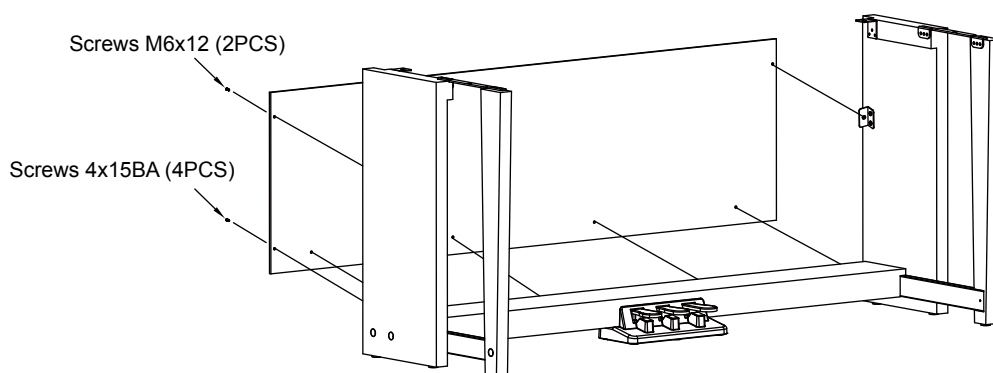

- C. Put the piano body on the top of the assembly finished by part B, then Use 2 pieces of Hand screws and 2 pieces of M6x18 screws to stable.

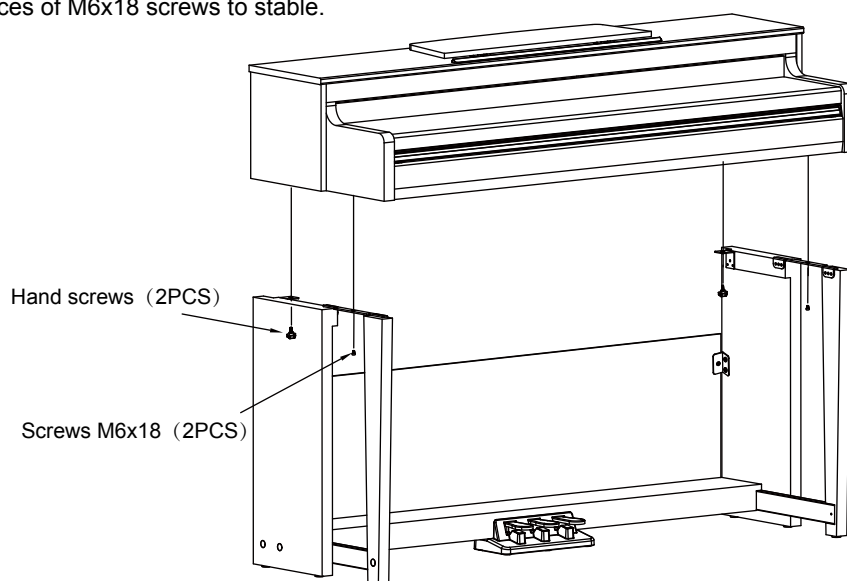

Setup

D. Connect pedal cable with the piano body bottom pedal jack, and connect the AC power adaptor to the DC in terminal.

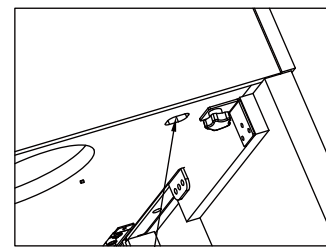
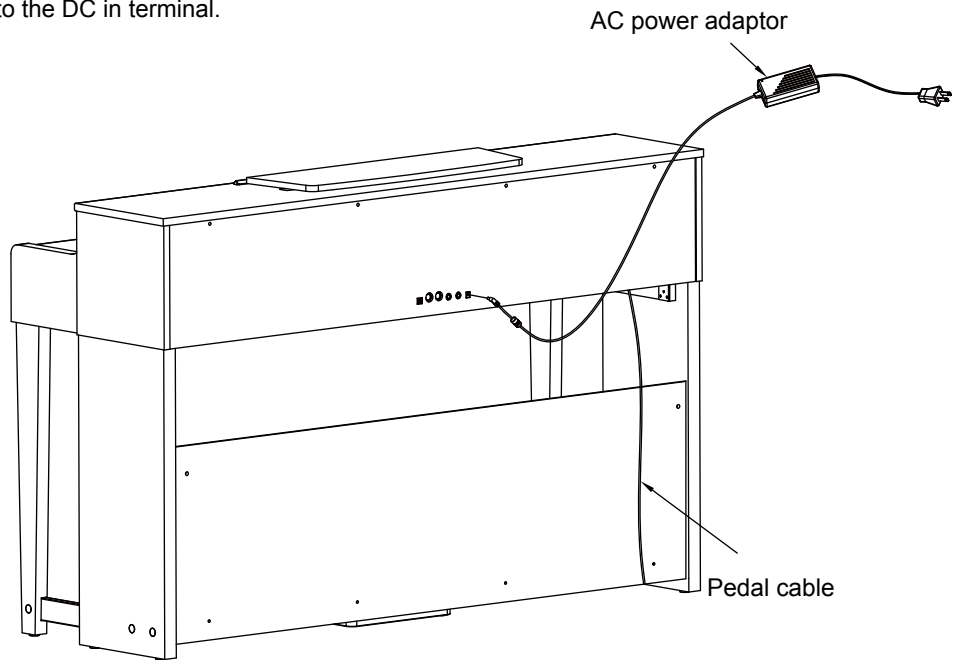

Pedal jack

Connections

Connecting a Pair of Headphones

Plug a pair of standard stereo headphones to the PHONES jack for private practice or late-night playing.

Jack 1: When a pair of headphones is plugged into Jack 1, sound can be heard from both headphones and speakers.

Jack 2: When a pair of headphones is plugged into Jack 2, the internal speakers are automatically shut off, sound can only be heard from the headphones.

Note:

To avoid the risk of hearing loss, do not listen with headphones at high volume level for a long period of time.

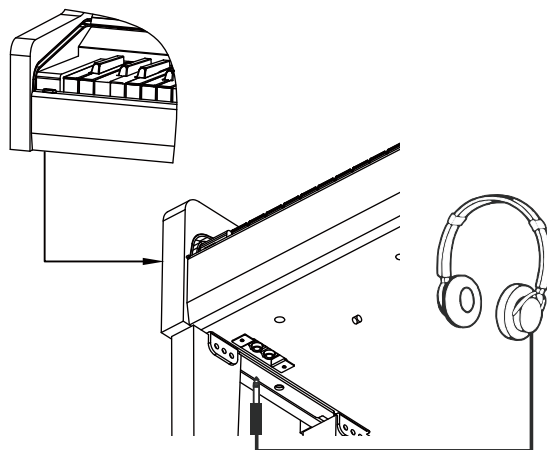

Connecting an Audio Equipment

The rear-panel AUX OUT jack delivers the output of the instrument to external audio equipment such as a keyboard amplifier, a stereo sound system, a mixing console, or a tape recorder.

Use an audio cable to connect the AUX OUT jack of the instrument to the AUX IN jack of the external audio equipment.

Notes:

1. Turn off the power to all units before connecting the external equipment.
2. To avoid damaging the speakers, please set the volume level to minimum before turning on the power.

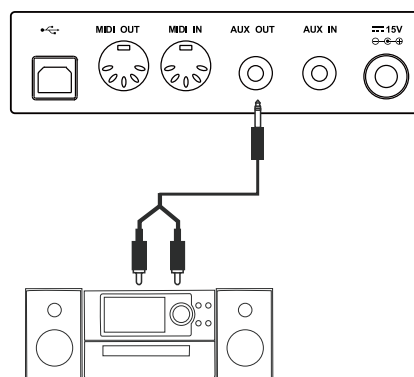

Connecting an MP3/CD Player

The rear-panel AUX IN jack receives audio signals from external audio source such as an MP3 or a CD player.

Use an audio cable to connect the AUX IN jack of the instrument to the AUX OUT jack of the MP3/CD player. The input signal will be mixed with the internal signal, allowing you to play along.

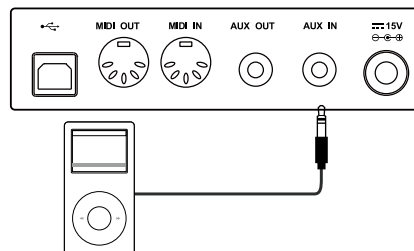

Connecting a Computer or a MIDI Device

MIDI IN Jack

Use a standard MIDI cable to connect the MIDI IN jack of the instrument to the MIDI OUT jack of an external device. The instrument will receive MIDI messages from the external device and work as a sound source.

MIDI OUT Jack

Use a standard MIDI cable to connect the MIDI OUT jack of the instrument to the MIDI IN jack of an external device. The instrument will transmit MIDI messages to the external device and work as a MIDI controller.

USB Jack

Use a standard USB cable to connect the USB jack of the instrument to the USB port of a computer. You can transmit MIDI messages between the instrument and the computer.

You can upload user songs to the computer as a backup or download MIDI files from the computer and play them on the instrument.

Note:

Do not set the USB device to be input and output simultaneously when setting the software on computer. Otherwise, the sound will be overlapped when playing the keyboard.

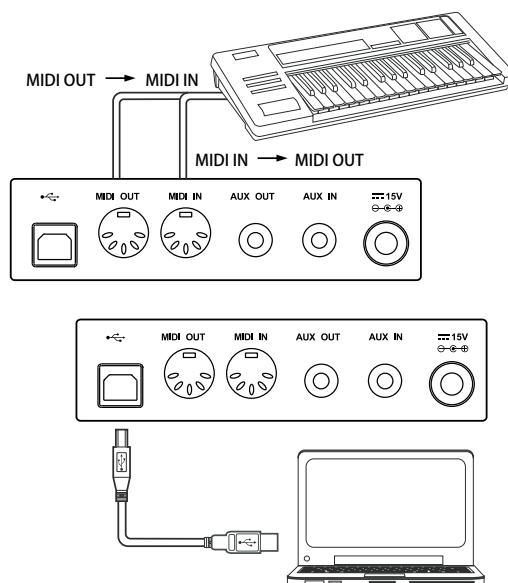

Quick Start

Power Supply

1. Make sure the instrument is powered off. Then turn down the volume.
2. Connect the AC adaptor to the DC IN jack of the instrument.
3. Plug the AC adaptor to an AC outlet.
4. Press and hold the [POWER] button, until the display shows "0.01", which indicates the instrument is powered on.
5. If you are ready to turn off the instrument, press and hold the [POWER] button until the display lights off.

Notes:

1. The instrument will automatically shut down after 30 minutes if it is not used. To turn off the function, press and hold the key "A0" and then turn on the power.
2. For your safety, please unplug the instrument when it is not in use or during a thunderstorm.

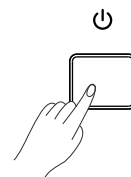

Adjusting the Master Volume

Rotate the [VOLUME] knob clockwise to increase the master volume or anticlockwise to decrease it. You can use the knob to set the desired volume level.

Note:

If the keyboard keeps silent, check if the volume is set to minimum or headphones are plugged into Jack 2.

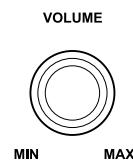

Adjusting the Voice Brilliance

Rotate the [BRILLIANCE] knob clockwise to make the voice sounds brighter, or anticlockwise to make it sounds mellow. You can use the knob to set the desired brilliance level.

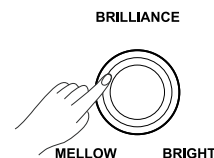

Playing the Demo Songs

The instrument features a number of wonderful demo songs. Please refer to the Demo List.

1. Press both the [STYLE] and [SONG] buttons simultaneously to enter the demo mode. It will play all demo songs in a loop. The display shows the current demo number.
2. Use the [+ / YES] / [- / NO] button to select a demo song.
3. Press the [START / STOP] button to stop and exit the demo mode. Or press again both the [STYLE] and [SONG] buttons to stop and exit the demo mode.

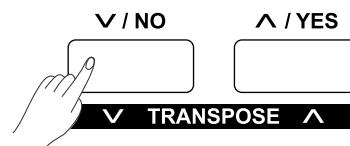
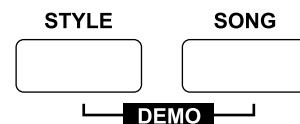

Playing the Voices

The instrument features a variety of exceptionally realistic voices. Please refer to the Voice List.

1. Press the [VOICE] button to enter the voice mode. The display shows the current voice number, such as "0.01".
2. Use the [+ / YES] / [- / NO] button to select a desired voice. Or press the VOICE select buttons to select a preset voice.
3. Play the keyboard and enjoy the wonderful voice.

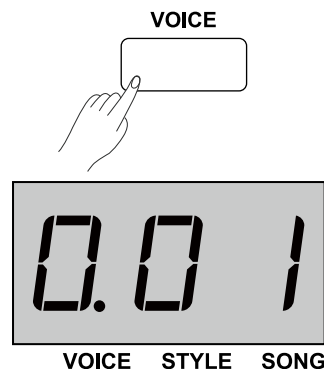

Playing the Styles

The instrument features a variety of styles. Please refer to the Style List.

1. Press the [STYLE] button to enter the style mode. The display shows the current style number, such as "00.1".
2. Use the [+ / YES] / [- / NO] button or the keys marked [STYLE0-9] to select a desired style.
3. Press the [START/STOP] button, and then play in the left hand area to start playing the style.

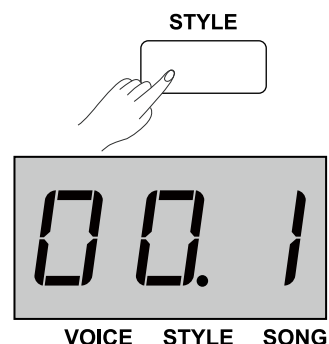

Note:

If you use the keys marked [STYLE 0-9] to select a desired style, press and hold [SHIFT], then tap two number keys. For example, tap 0, 8 in sequence to select the 08 style.

Playing the Songs

The instrument has a variety of preset songs. Please refer to the Song List.

1. Press the [SONG] button to enter the song mode. It will start playing all songs in a loop. The display shows the current song number, such as "001".
2. Use the [+ / YES] / [- / NO] button or the keys marked [SONG 0-9] to select a desired song.
3. Press the [START/STOP] button to stop the playback. Press it again to play the current song in a loop.
4. When playback stops, press the [STYLE] or [VOICE] button to exit the song mode.



Note:

If you use the keys marked [SONG 0-9] to select a desired song, press and hold [SHIFT], then tap two number keys. For example, tap 0, 8 in sequence to select the 08 song.

Quick Start

Recording

You can record up to 5 user songs on the instrument.

1. Press the [RECORD] button to enter the user song menu. The display shows the current user song number. Use the [+ / YES] / [- / NO] button to select a user song to which the recording will be saved.
2. Press again the [RECORD] button to enter the recording standby mode. The [START / STOP] button indicator starts flashing. Now you can select the desired voice, style, etc.
3. Press the [START / STOP] button or play the keyboard to start the recording. The [RECORD] button indicator lights up.
4. Press the [RECORD] button to stop and exit recording, the button indicator lights off. The user song will be saved automatically.
5. Press the [PLAY / STOP] button to enter the playback mode. The button indicator lights up. You can use the [+ / YES] / [- / NO] button to select a user song. Then press again the [PLAY / STOP] button to start the playback.
6. During the playback, press the [PLAY / STOP] to stop and exit the playback.
7. In the playback mode, if you press the [RECORD] button, the display will show "dEL". It will delete the song after confirmation. Press [+ / YES] to delete it or press [- / NO] to cancel and go back to the playback mode.

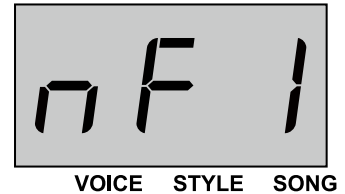
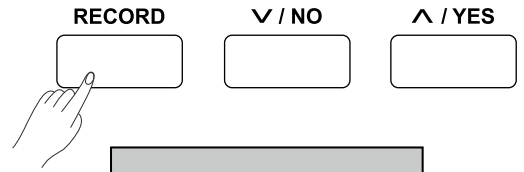

START / STOP

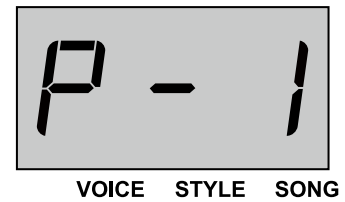
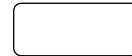

PLAY / STOP



RECORD

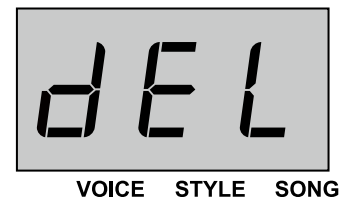
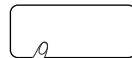

Playing the Voices

The instrument features a variety of exceptionally realistic voices. Please refer to the Voice List.

Playing a voice

1. Press the [VOICE] button or one of the VOICE select buttons to enter the voice mode. The voice indicator lights up. The display shows the current upper voice number, such as "0.01".
2. Use the [+ / YES] / [- / NO] button or the VOICE select buttons to select a desired voice.
3. Play the keyboard and enjoy the wonderful voice.

Note:

When the dual and lower functions are turned on, you can press the [VOICE] button repeatedly to shift between the upper, dual or lower voice. The selected one will be highlighted on display, as shown on the right.

Playing Two Voices Simultaneously - Dual

The dual function allows two different voices to be layered together, creating a much richer sound. Turn the function on, you can select a second voice for the dual voice.

1. Select the desired upper voice.
2. Press the [DUAL] button to turn on the dual function. The dual indicator lights up. The display shows the current dual voice number, such as "d.30".
3. Use the [+ / YES] / [- / NO] button or the VOICE select buttons to select the desired dual voice.
4. Play the keyboard, and you will hear two different voices layered together, just like two different instruments playing at the same time.
5. Press again the [DUAL] button to turn off the function. The dual indicator lights off.

Note:

When the keyboard is split, only the right hand area will use the dual function.

Playing Different Voices with Both Hands - Lower

The lower function splits the keyboard into the left and the right hand areas, each with a different voice. The left hand voice is the lower voice. The split point can be assigned to any key as desired.

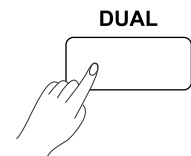
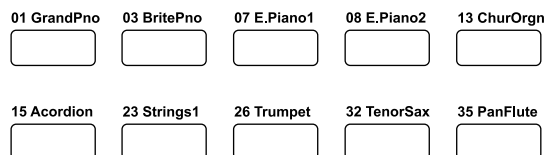
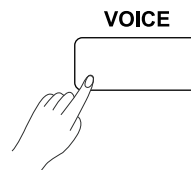

Advanced Use

1. Select the desired upper voice.
2. Press the [LOWER] button to turn on the lower function. The lower indicator lights up. The display shows the current lower voice number, such as "L.23".
3. Use the [+ / YES] / [- / NO] button or the VOICE select buttons to select the desired lower voice.
4. Play the keyboard with both hands, and you will hear two different voices from the two areas.
5. Press again the [LOWER] button to turn off the function. The lower indicator lights off.

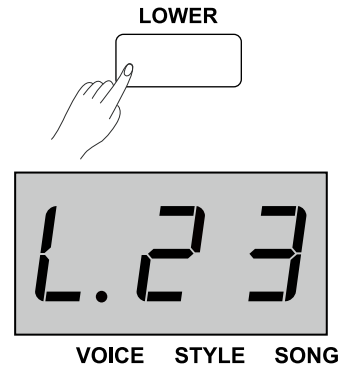

Split point :

The point on the keyboard that separates the lower voice from the upper and dual voices is called "split point". The default split point is at F#3 (34) , however you can assign it to any other key.

1. Press and hold the [LOWER] button, then press a key to assign the split point to that key.
2. Release the [LOWER] button, it will automatically exit the split point setting.

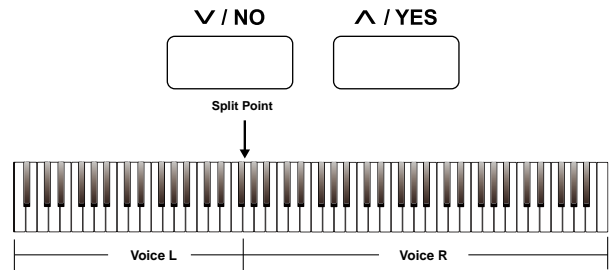

Playing Voice Demo

1. In voice mode, press the [VOICE DEMO] button to play the upper voice demo.
2. Press again the same button to stop the demo. Or press the [START/STOP] button to stop the demo.

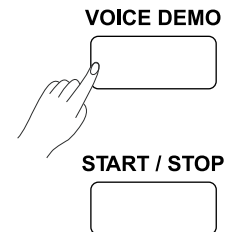

Touch Sensitivity

The touch response feature allows you to dynamically and expressively control the level of the voice with your playing strength, just as on an acoustic instrument.

There are 3 touch levels on the instrument (Off, 1-3), the default setting is: "2".

1. Press and hold [SHIFT], then use the keys marked [TOUCH+/-] to select an appropriate touch level.

Display	Description
OFF	Fixed
1	Soft
2	Medium
3	Hard

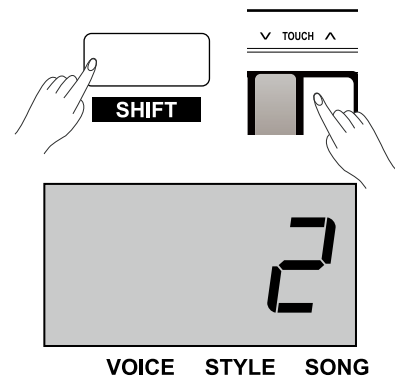

Transpose

The transpose function allows the overall pitch of the instrument to be transposed up or down by maximum of one octave in semitone steps.

1. Press and hold [SHIFT], then press the [Transpose+]/[Transpose-] button to enter the setting menu. The display shows the current transpose value, such as "00".
2. Use the [Transpose+]/[Transpose-] button to set the desired transpose value, over the range of ± 12 semitones.
3. Press and hold [SHIFT], then press both the [Transpose+] and [Transpose-] buttons to reset to default: 00.

Notes:

1. For example, set the transpose value to -05 or 007, then you can play the G scale using C scale keys.
2. Transpose setting applies to the chord accompaniment and the entire keyboard voice.

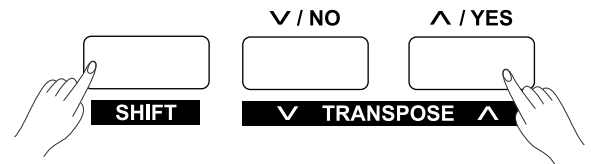

Tune

This function sets the pitch of entire keyboard in a 2-cent increment.

1. Press and hold [SHIFT], then press the key marked [TUNE+]/[TUNE-] to enter the setting menu. The display shows the current tune value. Then use the [TUNE+]/[TUNE-] key to set the desired tune value.
2. Press and hold [SHIFT], then press both the [TUNE+] and [TUNE-] keys to reset to default: 00.

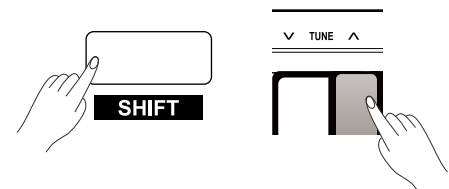

Key	Description
TUNE +	Increase entire keyboard pitch by 1 step.
TUNE -	Decrease entire keyboard pitch by 1 step.

Pedal Resonance

The pedal resonance function simulates the reverberation of notes when pressing the sustain pedal on an actual grand piano. With pedal resonance, it reproduces the rich harmonics and unique sound characteristics of an actual grand piano when using the sustain pedal.

1. Press and hold [SHIFT], then press the key marked [PEDAL RESONANCE] to turn on the function. Repeat the operation to turn off the function.
2. The default setting is "OFF".

Notes:

1. The chorus function is automatically turned off when you turn on the pedal resonance.
2. There might be a slight pause in the sound if you switch pedal resonance on/ off while performing.

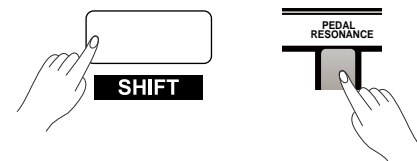

Advanced Use

Metronome

The Metronome function provides a steady beat to help you practise at a preset tempo.

1. Turn the metronome on/off

Press the [METRO] button to turn the metronome on or off.

When the metronome is on, the LED indicator of the [START/STOP] button will flash with the current tempo (Red for strong beat and green for weak beat). The tempo of the metronome can be freely adjusted. Please refer to the TEMPO.

2. Set the time signature

Press and hold [SHIFT], then use the keys marked [METRO +/-] to set the time signature, over the following options: 0, 2 ~ 9. The display shows the current time signature, such as "4".

Note:

The metronome function is not available in song mode.

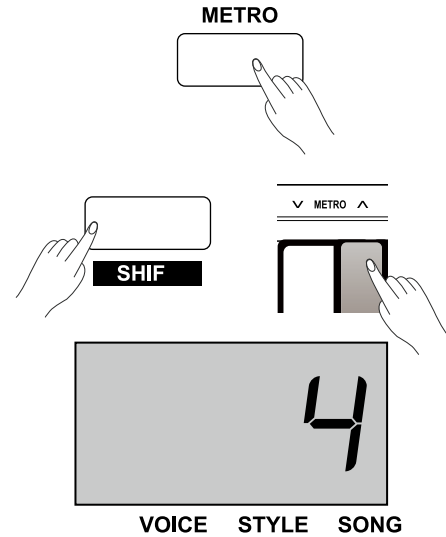

Auto Accompaniment

The instrument features a variety of piano styles. Please refer to the Style List.

Selecting a Style

1. Press the [STYLE] button to enter the style mode. The display shows the current style number, such as "00.1".
2. Use the [+ / YES] / [- / NO] button to select a desired style.
Or press and hold [SHIFT] then use the keys marked [STYLE 0-9] to select a style.

Note:

If you use the keys marked [STYLE 0-9] to select a desired style, press and hold [SHIFT], then tap 2 number keys. For example, tap 0, 8 in sequence to select the 08 style.

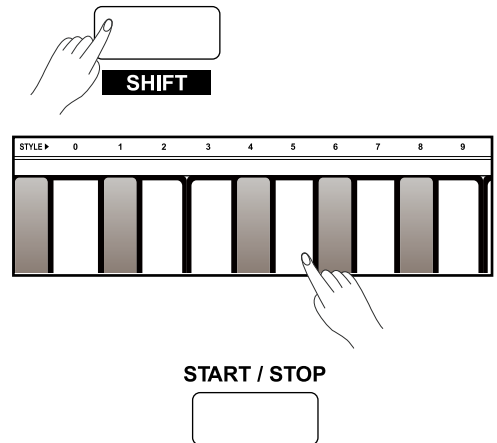
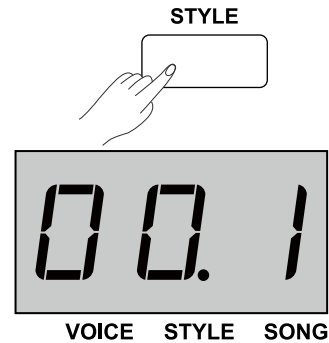

Playing the Style

1. In style mode, press the [START/STOP] button, and the button indicator will flash. The auto bass chord is automatically turned on. As soon as you play in the left hand area, the style will start playing.
2. Press again the [START/STOP] button to stop playing the style. It will turn off the auto bass chord.

Fill In A/B

1. When you start the accompaniment, it plays the default main A pattern, and the button indicator lights up.
2. Then press the [FILL A/B] button, it will play a fill-in pattern, and the button indicator will flash. When the fill-in completes, it will shift to the main B pattern, and the button indicator will light off.
3. Again, press the [FILL A/B] button, it will play a fill-in pattern, and the button indicator will flash. When the fill-in completes, it will shift to the main A pattern, and the button indicator will light up.

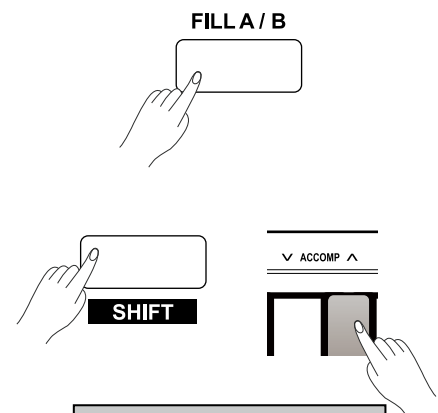

Accompaniment Volume

The function will adjust the accompaniment volume, so as to keep an appropriate balance between the accompaniment volume and the voice volume.

1. Press and hold [SHIFT], then use the keys marked [ACCOMP+] / [ACCOMP-] to adjust the accompaniment volume over the range of 0~127. The display shows the current volume value, such as "096".
2. Press both [ACCOMP+] and [ACCOMP-] keys simultaneously, it will turn off the accompaniment volume. The display shows "oFF". Repeat the operation to turn on the accompaniment volume.



Auto Accompaniment

Tempo

Each style, song, metronome, or duet pattern on the instrument is preset with a default tempo. However, you can adjust it with the [TEMPO] button, over the range of 30~280.

1. Press the [TEMPO+]/[TEMPO-] button to adjust the tempo value. The display will show the current tempo value.
2. Press both [TEMPO+] and [TEMPO-] buttons simultaneously to reset to the default value.
3. Press and hold [SHIFT], then press the keys marked [TEMPO 0-9] to set the tempo value. For example, press 2,1,4 in sequence to set the tempo value to 214.
4. Alternatively, press and hold [SHIFT], then tap the key marked [TAP] twice to set the desired tempo. It will start the click sound at the tempo you tapped.

Controls	Description
TAP	Quickly set the desired tempo.
TEMPO +/-	Increase or decrease the tempo value by 1.
0 ~ 9	Directly set the specific tempo value.

Note:

1. If you use the keys marked [TEMPO 0-9] to set the tempo, press and hold the [shift] button, then tap 3 number keys. For example, tapping 0,6,4 in sequence to set the tempo value to 064.
2. If you tap the [TAP] key rightly equal to the current time signature, the metronome will start at the speed of the last interval.

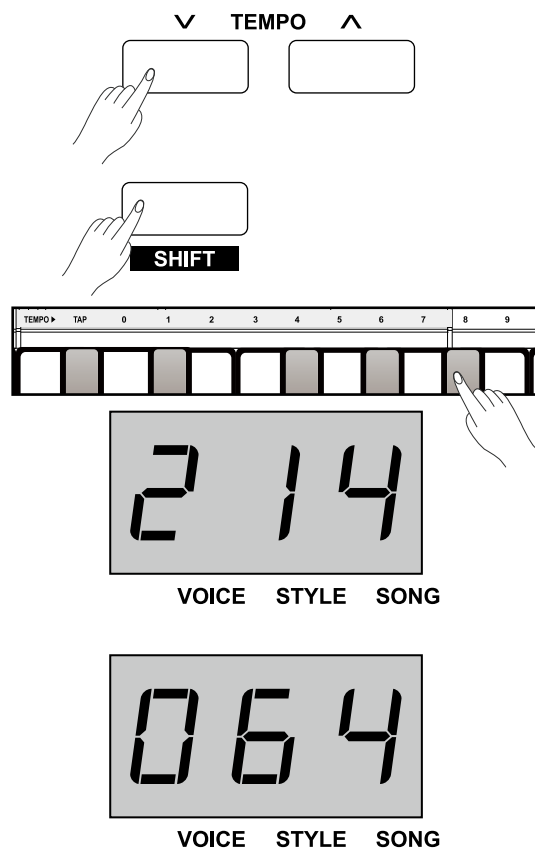

The DSP simulates sounds in real environment. With the DSP effect, you can add ambiance and depth to your performance in a variety of ways.

Reverb

Press and hold [SHIFT], then use the keys marked [REVERB +/-] to set the reverb type, over the options: OFF, 1~5. Default is 2 Hall.

Setting	Reverb Type
OFF	NO reverb effect
1	Room
2	Hall
3	Church
4	Delay
5	Pan Delay

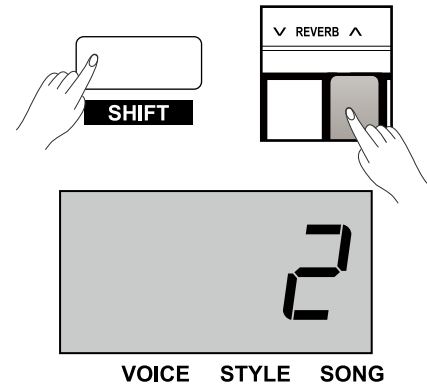

Chorus

Press and hold [SHIFT], then use the keys marked [CHORUS +/-] to set the chorus type, over the options: OFF, 1~5. Default is OFF Chorus.

Setting	Chorus Type
OFF	NO chorus effect
1	Chorus 1
2	Chorus 2
3	Chorus 3
4	Flanger
5	Rotary

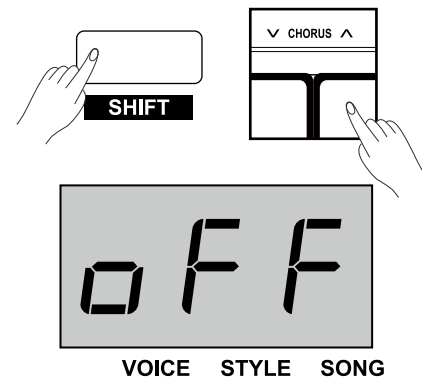

EQ

An equalizer controls the gain value of different frequency bands. Different gain setting will produce different sound effect.

Press and hold [SHIFT], then use the keys marked [EQ +/-] to set the EQ type, over the options: 1~5. Default is 1 Standard.

Setting	EQ Type
1	Standard
2	Modern
3	Rock
4	Classic
5	Jazz

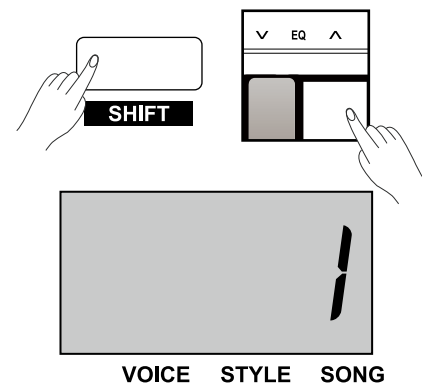

Song

Listening to the Songs

This instrument features some beautiful piano songs. Please refer to the Song List.

1. Play all songs in a loop
Press the [SONG] button to enter the song mode. It will play all preset songs in a loop. The song indicator lights up and the display show the current song number, such as "001".
2. Play the current song in a loop
When song playback stops, press the [START/STOP] button to play the current song in a loop.
3. Select a song
Use the [+ / YES] / [- / NO] button to select a song. Or press and hold [SHIFT], then use the keys marked [SONG 0-9] to select a desired song.
Note:
If you use the [SONG 0-9] keys to select a song, press and hold [SHIFT], then tap 2 number keys. For example, tap 0,8 in sequence to select the 08 song.
4. Stop the song
During song playback, press the [START/STOP] button or the [SONG] button to stop the song.

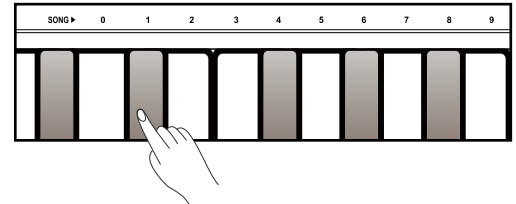
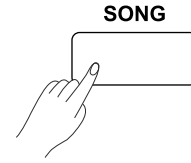

Practise the Songs

All preset songs can be practised with melody-off.

1. Press and hold [SHIFT], then press the [LEFT] button to turn off the left-hand melody. You can practise the left hand part of the song.
2. Repeat the above operation to turn on the left-hand melody of the song.
3. In the same way, press and hold [SHIFT], then press the [RIGHT] button to turn off the right-hand melody. You can practise the right hand part of the song.

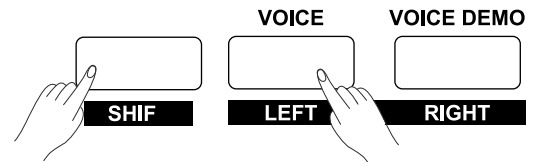

Song Recording

The easy-to-use song recording features allows you to record in real-time your keyboard performance, save it as a user song, and then play it back. You can record up to 5 user songs on the instrument.

Prepare Recording

1. Before recording starts, you need to select a user song to which the recording will be saved.
Press the [RECORD] button to enter the user song menu. The display shows the current user song number. Use the [+ / YES] / [- / NO] button to select a user song. If a user has data, the display will show "r-*", otherwise, it will show "nF*".

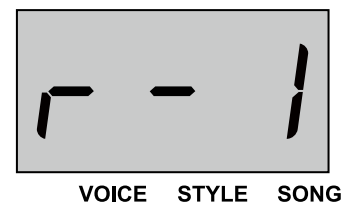
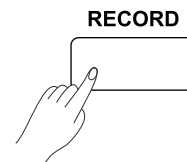

2. Press again the [RECORD] button to enter the recording standby mode. The [START/STOP] button indicator starts flashing. Now you can set the desired voice, style, tempo etc. The Lower function is automatically disabled.

Start Recording

1. In recording standby mode, play the keyboard to start the recording. The [RECORD] button indicator lights on.
2. You can also press the [START/STOP] button to turn on the auto bass chord and start recording. The style is ready to play. As soon as you play in the left hand area, the style starts playing and the accompaniment will be recorded as well.

Note:

If the user song you select shows "r-*" (with recording data), the original data will be replaced with new data after the recording.

Stop Recording

1. During recording, press the [RECORD] button to stop recording. It will automatically save the recording and the display shows "- - -". After saving, the [RECORD] button indicator will light off.
2. During recording, if the memory gets full, it will automatically stop and save the recording. The display shows "FUL". After saving, the button indicator will light off.

Play a User Song

1. When recording stops, press the [PLAY/STOP] button to enter the playback mode. Use the [+ / YES] / [- / NO] button to select a user song. If the user song has data, it will show "P-*", such as "P-2", otherwise, it will show "nF*".
2. Press again the [PLAY/STOP] button to play the selected user song. The button indicator lights up.
3. During playback, press the [PLAY/STOP] button to stop playing. The button indicator lights off.

Delete a User Song

1. Press and hold both [PLAY/STOP] and [RECORD] buttons, then turn on the power. All user songs will be deleted.
2. In playback mode, press the [RECORD] button, the display will show "dEL". Press [+ / YES] to delete the user song. Press [- / NO] to cancel and go back to the playback mode.

Note:

The saved user songs will not be lost after power off.

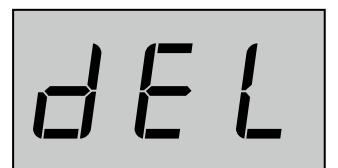
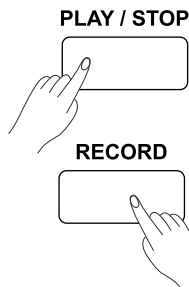
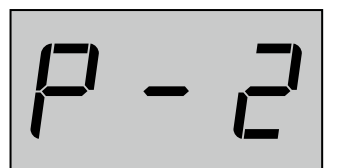
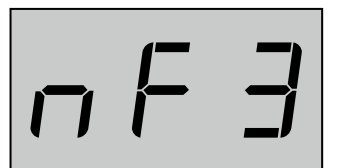
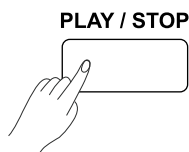
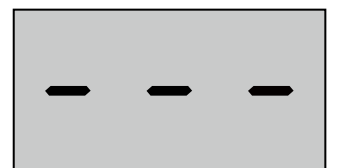
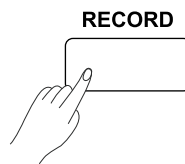
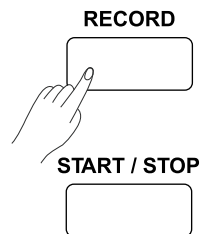

Duet

The duet function will add dynamic elements of a professional-sounding arrangement to your performance. Simply play a chord with your left hand, and the instrument will play a preset duet pattern to produce a beautiful melody.

Turn the Duet on/off

1. Press the [DUET] button to turn on the function. The button indicator lights up and the display show the current duet pattern number, such as “d01”.
2. Press again the [DUET] button to turn off the function. The button indicator lights off and the display shows “oFF”.

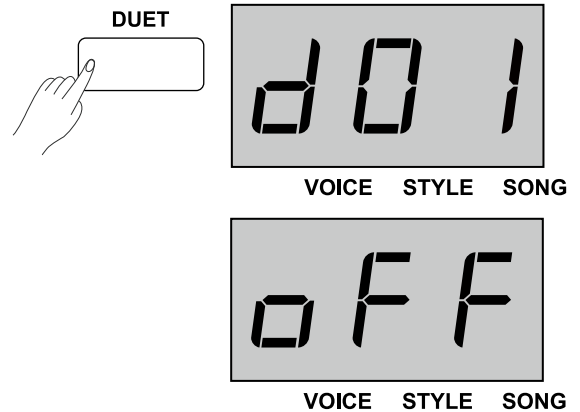

Select a Duet pattern

Press and hold [SHIFT], then use the keys marked [DUET +/-] to select a duet pattern. The display will show the current duet pattern number, such as “d01”. The instrument has 32 duet patterns and the default is “d01”.

Note:

Each voice is matched with a preset duet pattern, so when you change the voice, the duet pattern will change as well.

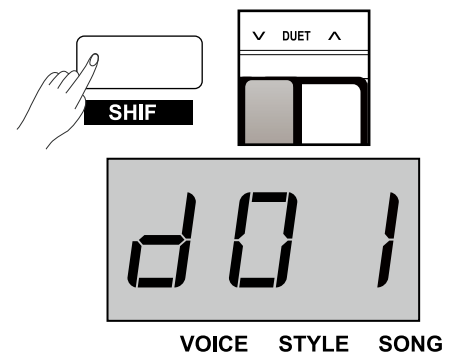

Set the Duet split point

When the duet function is in use, the keyboard is automatically split into two sections: a chord section in the left-hand area and a melody section in the right-hand area. The default split point is the same as in the lower function: F#3 (34).

1. Press and hold the [LOWER] button, then press a key to assign the split point to that key.
2. Release the [LOWER] button and it will automatically exit the setting menu.

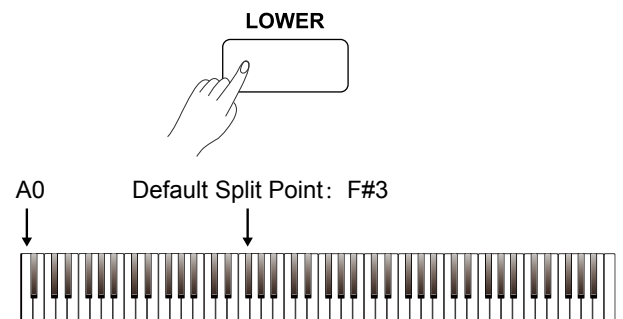

The TWINOVA mode splits the keyboard into two independent areas, both have the same pitch and voice, for the convenience of one-to-one teaching.

Turn the twinova on/off

1. Press the [TWINOVA] button to turn on the function. The display shows "on". The default split point is E3 (32).
2. Press the button again to turn off the function.

Note:

In TWINOVA mode, both the dual and lower function is automatically disabled.

Select a voice

The default voice of right hand and left hand is the upper voice you have selected before entering the TWINOVA mode. You can press one of the VOICE select buttons or the [+YES]/[-NO] button to select a desired voice.

Set the split point

In TWINOVA mode, press and hold the [LOWER] button, then tap a key between C3 and C6 to set the split point to that key. It will exit the setting menu when you release the [LOWER] button.

Set the octave

This function will raise or lower the pitch of the entire keyboard by an octave. The octave is adjustable only when TWINOVA is engaged. When Twinova is disabled, the keyboard will return to normal pitch level and the octave will become unavailable.

Press and hold [SHIFT], then use the keys marked [OCTAVE+/-] to set the octave value. The display shows the current octave value, such as "0".

Note:

TWINOVA is unavailable in song mode or demo mode.

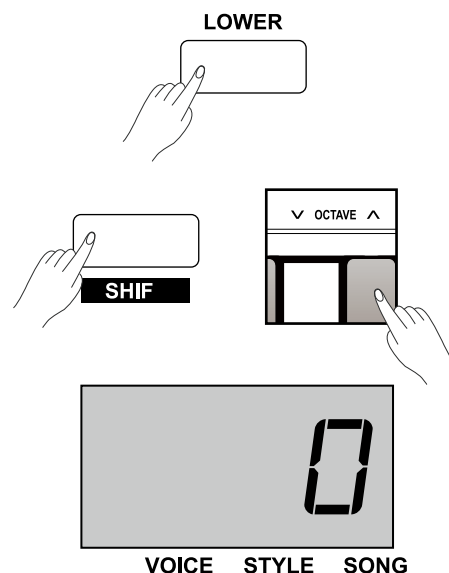
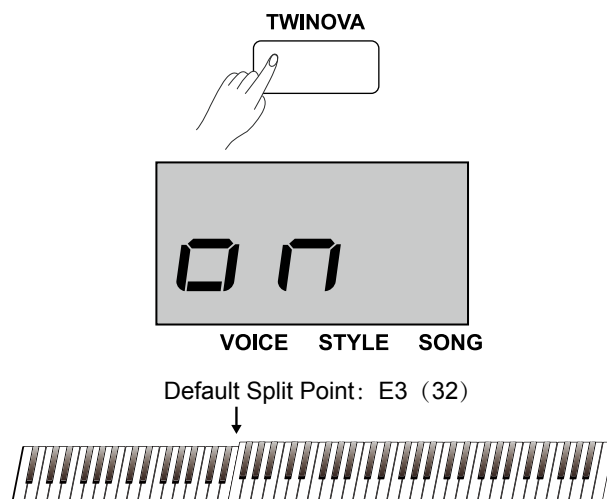

Beep Tone

When the beep tone is in use, you can hear a prompt sound whenever you change the settings. The default setting is on.

Press and hold [SHIFT], then press the key marked [BEEP] to turn the tone on or off.

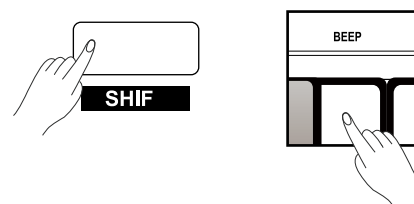

MIDI

By using the MIDI functions, you can expand your musical possibilities. This section explains what MIDI is, and what it can do.

What's MIDI?

MIDI (short for Musical Instrument Digital Interface) allows a wide variety of electronic musical instruments, computers and other related devices to connect and communicate with one another. MIDI carries event messages that specify notation, pitch and velocity, control signals for parameters such as volume, vibrato, audio panning, and program change information to change the voice selections.

The instrument can output the real-time playback information via MIDI messages and control external MIDI devices. The instrument can also accept incoming MIDI messages and generate sound accordingly.

Note:

The USB jack at the rear panel is a USB device connector, which can only be connected to a computer or a USB host connector.

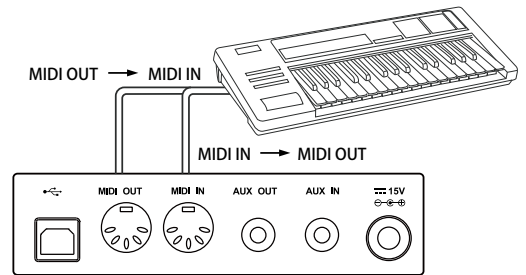
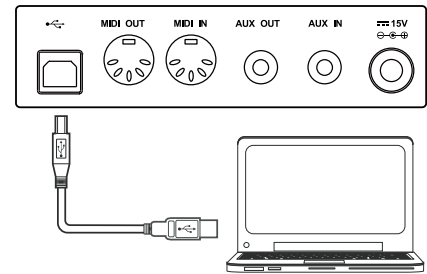

Troubleshooting

Problem	Possible Cause and Solution
The speakers produce a pop sound whenever the power is turned ON or OFF.	This is normal and is no cause for alarm.
No sound when the keyboard is played.	1. Make sure the master volume is set to an appropriate level. 2. Check if headphones are plugged into Jack 2.
When using a mobile phone, noise is produced.	Using a mobile phone in close proximity to the instrument may produce interference. To prevent this, turn off the mobile phone or use it further away from the instrument.
Certain Note sound at wrong pitch.	Make sure that the tuning value is set to 0. Press and hold the [+ / YES] and [- / NO] buttons and turn on the power, the instrument will restore factory setting.
After connecting with a computer, the instrument cannot be recognized.	Please check if the USB cable is being connected firmly, or try connecting another USB port on the computer, without the need to install another driver on the PC.

Specification

Keyboard

88 Graded Hammer-Action Keys with Triple Sensors

Polyphony

128

Voice

40

Style

50

Song

60

Demo

2

Record

5 user songs

Control Button

Power switch, Volume, Brilliance, Play/Stop, Record, Style, Song, Demo, Start/Stop, Fill A/B, Tempo +/-, Voice (Left), Voice Demo (Right), Dual, Lower, -/No, +/Yes, Transpose +/-, Twinova, Shift, Voice select buttons.

Control Key

Beep, Pedal Resonance, Touch, Tune, Octave, Reverb, Chorus, EQ, Metro, Duet, Accomp, Tempo, Style, Song.

Connectors

DC IN, PHONES (2 standard. 1/4" phone), AUX IN, AUX OUT, USB, MIDI IN/OUT, PEDALS (Soft, Sostenuto, Sustain).

Power Supply

DC 15V/2.5A

Speaker

Woofer: 6 Ω 40W x 2

Tweeter: 4 Ω 25W x 2

Dimensions

1400(L) x 492(W) X 910(H) mm

Weight

59Kg

* All specifications and appearances are subject to change without notice.

Voice List

NO.	Name
1	Acoustic Grand Piano
2	Acoustic Grand Piano (wide)
3	Bright Acoustic Piano
4	Electric Grand Piano
5	Honky Tonk Piano
6	Harpsichord
7	Electric Piano 1
8	Electric Piano 2
9	Clavi
10	Drawbar Organ
11	Percussive Organ
12	Rock Organ
13	Church Organ
14	Reed Organ
15	Accordion
16	Tango Accordion
17	Nylon Guitar & Acoustic Bass
18	Steel Guitar & Finger Bass
19	Slap Bass & Vibraphone
20	Violin
21	Cello
22	Orchestral Harp
23	String Ensembles 1
24	String Ensembles 2
25	Choir Aahs
26	Trumpet
27	Trombone
28	Tuba
29	French Horn
30	Soprano Sax
31	Alto Sax
32	Tenor Sax
33	Baritone Sax
34	Flute
35	Pan Flute
36	Sitar
37	Banjo
38	Shamisen
39	Koto
40	Bag Pipe

Style List

NO.	English Name
1	Romantic 8beat
2	Pop 8Beat
3	Slow Rock
4	Lyric 3Beat
5	Pop Waltz
6	Slow Waltz
7	Waltz1
8	Waltz2
9	Waltz3
10	Vienna Waltz
11	1 - Mar
12	2 - Mar
13	Polka
14	Italian Polka
15	Jazz Pub
16	Jazz 1
17	Jazz 2
18	Jazz 3
19	Jazz 4
20	Jazz 5
21	Boogie
22	Jive
23	Dixland
24	Latin
25	Tango
26	Lambada
27	Samba
28	ChaCha
29	Beguine
30	Salas
31	Pop Bossa
32	Blues1
33	Blues2
34	Blues3
35	Jazz Bluse
36	Piano Beat
37	Piano Bar
38	Pop 1
39	Pop 2
40	Pop 3
41	Pop 4
42	Pop Country
43	Pianist 1
44	Pianist 2
45	Ballad 1
46	Ballad 2
47	Ballad 3
48	Ballad 4
49	6/8 Ballad
50	6/8Ballad 2

Song List

NO.	English Name
1	The entertainer
2	Rialto Ripples (Rag)
3	Neapolitan Song
4	Waltzes
5	Turkish March
6	Schos Doll's Dance No. 2
7	Minuet In D Major
8	Inquietude
9	Italian Polka
10	Moment Musical
11	Prelude In C-Sharp Major
12	The Happy Farmer
13	The Rag-Time Dance
14	Piano Sonata In C Major, K.330. III
15	Mazurka
16	Prelude In E Major
17	Piano Sonata In A Major, K.331. I
18	Waltz For Piano In G-Sharp Minor
19	Gavotte
20	L' Arabesque
21	Austria Variation
22	Schos Doll's Dance No. 7
23	To A Wild Rose
24	Gavotte I
25	Waltz
26	Minuet In G Major (BWV Anh. 116)
27	Innocence
28	Tchaikovsky Waltz
29	Salut d' Amour
30	Barcarolle
31	Robot Doll
32	Consolation
33	2-Part Invention #13 In A Minor.B.W. Iii
34	Minuet In G Major (BWV Anh. 114)
35	Barcarolle
36	Norwegian Dance No.2
37	Moseta Dance
38	The Small Gathering
39	The Return
40	The Wagtail
41	Bulie Dance
42	Tender Blossom
43	Grace
44	Cherish The Memories
45	Chopsticks
46	Four Little Swans
47	Progress
48	Eclogue
49	The Limpid Stream
50	Brave Cavalier
51	The Chatterbox
52	Tarantella
53	Frankness
54	Tender Grieving
55	The Farewell
56	The Chase
57	Habanera
58	Prelude In C Major
59	Fountain
60	Fur Elise

Demo List

No.	English Name
1	Fantasia
2	Chpn_op25_no1

MIDI Implementation Chart

Function		Transmitted	Recognized	Remarks
Basic Channel	Default Changed	1ch 1-16ch	ALL 1-16ch	
Mode	Default	x	3	
	Messages	x	3	
	Altered	*****	x	
Note Number	Note :True voice	0—127 *****	0—127 0—127	
Velocity	Note on Note off	o 9nH,V=1-127 x (9nH,V=0)	o 9nH,V=1-127 o(9nH,V=0; 8nH,V=0-127)	
After Touch	key's Ch's	x x	x x	
Pitch Bend		x	o	
Control Change	0 1 5 6 7 10 11 64 65 66 67 80 81 91 93 120 121 123	o x x o o x x o x o o o o x x o	o o o o o o o o o o o o o o o x o	Bank Select Modulation Portamento Time Data Entry Volume Pan Expression Sustain Pedal Portamento ON/OFF Sostenuto Pedal Soft Pedal Reverb Program Chorus Program Reverb Level Chorus Level All Sound Off Reset All Controllers All Notes Off
Program Change	:true	o *****	o 0—127	
System Exclusive		x	o	
System Common	:SongPosition :Song Select :Tune	x x x	x x x	
System Real Time	:Clock :Commands	o x *1	x x *1	
Aux Messages	:LOCAL ON/OFF :Active sense :Reset	x o x	x o o	
Notes: *1 When the accompaniment is started, an FAH message is transmitted. When accompaniment is stopped, an FCH message is transmitted.				

- Mode 1: OMNI ON, POLY
- Mode 2: OMNI ON, MONO

- Mode 3: OMNI OFF, POLY
- Mode 4: OMNI OFF, MONO

- o: YES
- x: NO

