



®



WDC-900

Digital And wireless
discussion conference
systems



100% recycled paper
100% papier recyclé

Operating Instructions

Table of Contents

Thank you for choosing Relacart's Wireless conference System.

Please carefully follow the instructions in this manual to ensure durable, trouble-free use of your equipment.

1.Safety Precautions.....	P2
2.General Description.....	P4
3.Features.....	P5
3.1Central Controller Unit WDC-900M.....	P5
3.2Chairman Unit WDC-900C.....	P7
3.3Delegate Unit WDC-900D.....	P9
4.Operation and Functions Settings.....	P11
4.1Initiating System.....	P11
4.2WDC-900M Functions Settings.....	P11
4.3WDC-900M Menu Displays.....	P16
5.Optional for Automatic Video Tracking System VTS-1000.....	P17
5.1General Description.....	P17
5.2Features.....	P17
5.3VTS-1000 Functions Settings.....	P20
5.4VTS-1000 Menu Displays.....	P24
6.Installation and Connections.....	P25
6.1System Connection Examples.....	P25
6.2Notes on Installation of the Antennas.....	P26
6.3Antennas Installation Examples.....	P27
7.Accessories.....	P28
7.1Antenna R-2.4C / R-2.4B.....	P28
7.2Charging Case RC-10N / RC-20N.....	P29
8.Specifications.....	P31

01 Safety Precautions

Applicable to Ni-NH(AA) Battery

- Should the following irregularity be found during use, immediately switch off the power, take the batteries out of the unit, and keep them away from fire. Failure to do so may cause fire or explosion.
 - If you find battery leakage, discoloration, deformation or damage.
 - If you detect smoke or a strange smell coming out from the batteries.
- Do not deform, modify, or solder the batteries. Doing so may damage the battery's safety or protector mechanism, causing the batteries to fire, leak, or explode.
- Never short the positive and negative terminals with a wire or other metallic objects. Also, avoid carrying or keeping the batteries with metallic objects such as necklaces or hair pins. Doing so may cause the batteries to fire, explode, leak, or heat.
- Never heat the batteries nor throw them into a fire. Doing so may damage to the battery's gas relief valve or safety mechanism, causing the batteries to fire or explode.
- Do not dip the batteries into water nor wet the battery terminals. This may corrode the batteries, possibly causing them to fire, explode, leak, or heat.
- Note correct polarity (positive and negative orientation) when inserting the batteries into a battery charger. Doing otherwise may cause them to fire, explode, leak, or heat.
- Be sure to use the RC-10 charger when recharging the batteries. Using other battery charge may cause them to fire, explode, leak, or heat.
- Use the batteries only with equipment specified. Failure to do so may cause the batteries to fire, explode, leak, or heat.
- Do not drop the batteries nor give them a shock. Doing so may damage the battery's safety or protector mechanism, causing the batteries to fire, explode, leak, or heat.
- There is a fear of losing one's eyesight if a battery leakage gets in one's eyes. Wash it away with clean water and consult a doctor immediately. If a battery leakage stains or clothes, wash it away with clean water as there is a fear of impairing the skin.

Applicable to Central unit, Chairman unit, Delegate unit, Battery Charger, and AC adapter

- Never plug in nor remove the power supply plug with wet hands, as doing so may cause electric shock.
- When unplugging the power supply cord, be sure to grasp the power supply plug; never pull on the cord itself. Operating the unit with a damaged power supply may cause a fire or electric shock.
- When moving the unit, be sure to remove its power cord from the wall outlet. Moving the unit with the power cord connected to the outlet may cause damage to the power cord, resulting in fire or electric shock. When removing the power cord, be sure to hold its plug to pull.
- Do not block the ventilation slots on the unit. Doing so may cause heat to build up inside the unit and result in fire.
- Avoid installing the unit in humid or dusty locations, in locations exposed to the direct sunlight, near the heaters, or in locations generating sooty smoke or steam as doing otherwise may result in fire or electric shock.
- Do not place heavy objects on the unit as this may cause it to fall or break which may result in personal injury and / or property damage. In addition, the object itself may fall off and cause injury and / or damage.
- If dust accumulates on the power supply plug or in the wall AC outlet, a fire may result. Clean it periodically. In addition, insert the plug in the wall outlet securely.
- Switch off the power, and unplug the power supply plug from the AC outlet for safety purposes when cleaning or leaving the unit unused for 10 days or more. Doing otherwise may cause a fire or electric shock.

02 General Description

Designed to the most flexible discussion system available, RELACART has built on the elegant design to create a new series of digital and wireless discussion units with unrivaled features.

Operating in 2.4GHz (license free) band and Zigbee wireless communication technology, the digital and wireless discussion units produce high quality CD sound due to a very high fidelity circuit design. The system is protected against interference from other wireless equipments such as computers, mobile phones and blue-tooth devices. All signals within the WDC digital and wireless system are digitally protected against tapping or eavesdropping.

Set up easily and quickly with no impact on location, especially for historical locations, the benefits can be even more pronounced. One no longer has to worry about the damaging antique materials of a grand hall. No cables have to be laid or holes drilled, the RELACART WDC wireless discussion systems offer a professional and perfect solution for challenging locations.

- Zigbee wireless communication technology
- Control for up to 273 wireless discussion units and 2 chairman units, up to open simultaneous 4 discussion units.
- Absolutely safe, all signals within the WDC digital and wireless system are digitally protected against tapping or eavesdropping.
- Adjustable sensitivity for audio inputs and outputs.
- Earphone monitor function.
- Audio insertion facility to connect external audio processing devices or telephone couplers.
- 19"(2U) housing for table top or rack mounting
- Handgrips for easy transport.
- Bright LCD display operation screen, with Chinese and English Language menu for choose, perfect function and easy operation.
- Perfect sound quality as CD from the microphone.
- The system is perfectly protected against interference from other wireless equipments such as computers, mobile phones and blue-tooth devices.
- Easy to setup a system for usage limited in time, no impact on furniture, interior equipment or building structure
- Optional for Automatic Video Tracking System VTS-1000 for automatic camera tracking.
- Three operational microphone modes:
 - IN TURN: (with limited time): Allow one speaking unit only, and can set the microphone to open 0S to 999S, when the limited time is reach, subsequent microphone speaks.
 - APPLY: The operation of delegate unit should be approved by chairman unit or operator.
 - FIFO: First-in / First-out priority: When the maximum number of speakers is reach, subsequent Talk key units with override of activated microphones.

03 Features

3.1 Central Controller Unit WDC-900M

Front Panel

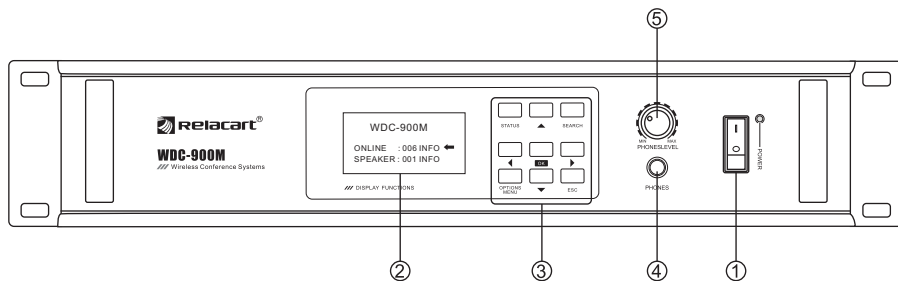

- ① Power Switch, setting this switch to the ON position cause the Power indicator to light.
- ② LCD displays operating status.
- ③ Operation keys.
- ④ Headphone jack (Mini-jack).
- ⑤ Headphone volume control.

Rear Panel

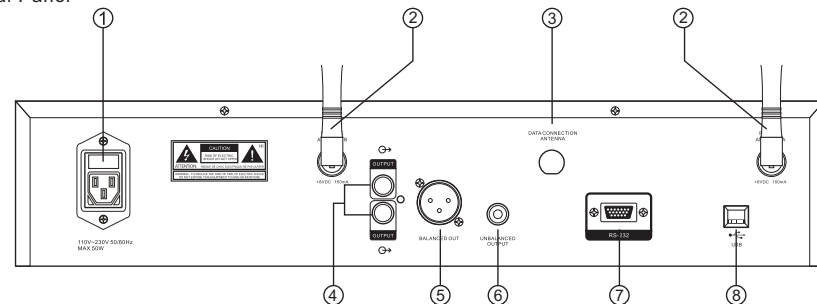

- ① Power Input: IEC type connector for 90V/240V 50/60Hz 20W without user adjustment.
- ② Receiving Antenna Input Jack A/B (BNC Jack): Attached the antenna directly.
- ③ Data connection Antenna input jack: Attached the antenna directly.
- ④ 2 RCA Audio Line Output: Can be connected to mixer or MD recorder.
- ⑤ Balanced Output Jack: XLR type connector. A standard 2 conductor shielded cable can be used to connect the receiver output to a balanced microphone level input on a mixer or integrated amplifier.
- ⑥ Unbalanced Output Jack: 1/4" (6.3mm) phone jack. Can be connected to an aux-level input of a mixer, guitar amp or tape recorder.
- ⑦ RS-232 Jack: Can be connected to Automatic Video Tracking System VTS-1000 or the other control systems.
- ⑧ USB jack: connect to computer.

3.2 Chairman Unit WDC-900C

[Top]

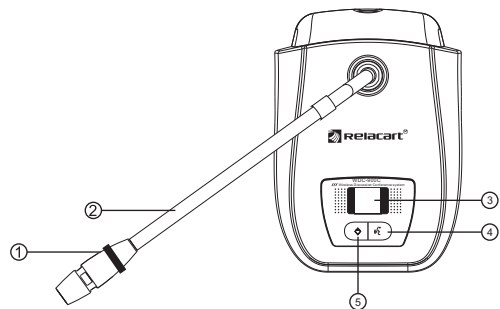

①Microphone in-use indicator: Lights when the microphone is turned on (for speech) and flashes when the battery level is low.

②Microphone: Use either standard length 420mm or longer dedicated microphone.

③LCD Window: Liquid Crystal Display indicates control setting and operational readings such as working status, operational mode and time, signal strength, battery condition, etc.

The window lights when there is a “applying” from the delegate unit.

④A: Talk key: When this key is pressed, the Microphone In-use indicator (①) lights, and the microphone turns on. Pressing this key again extinguishes the indicator and turns off the microphone.

Note: If Central unit is power off, even Talk key is pressed, the Microphone In-use indicator does not light, the microphone still turn off.

B: Approval Key: To approve the applying unit to speak when in APPLY mode.

⑤A: Priority speech key: Press this key continuously while speaking.

The microphone turns on and the Microphone In-use indicator (①) remains lit as long as the key is held down. Allowing the voice input from the unit to take precedence over other units. During this interval, other Delegate units cannot be used.

B: Reject Key: To reject the applying unit to speak when in APPLY mode.

[Bottom]

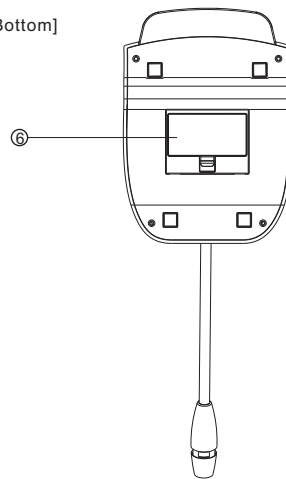

⑥AA battery compartment Install AA Battery in this compartment.

[Rear]

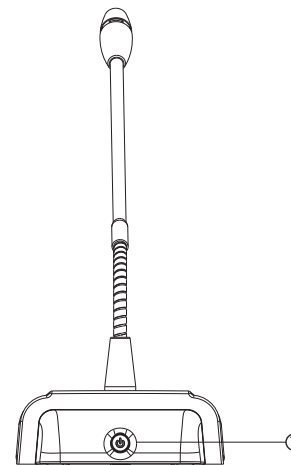

⑦Power switch: Press switch in 1 second to switch on the power, while in 3 seconds the power will be off.

3.3 Chairman Unit WDC-900D

[Top]

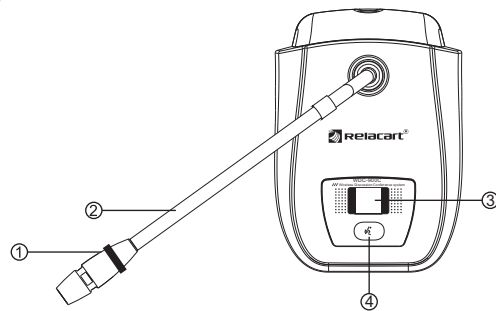

①A: Microphone in-use indicator: Lights when the microphone is turned on (for speech) and flashes when the battery level is low.
B: This indicator also flashes when the unit is applying to speak.

②Microphone: Use either standard length 420mm or longer dedicated microphone.

③LCD Window: Liquid Crystal Display indicates control setting and operational readings such as working status, operational mode and time, signal strength, battery condition, etc.

④Talk key: When this key is pressed, the Microphone In-use indicator (①) lights, and the microphone turns on. Pressing this key again extinguishes the indicator and turns off the microphone.

Note: If Central unit is power off, even Talk key is pressed, the Microphone In-use indicator does not light, the microphone still turn off.

[Bottom]

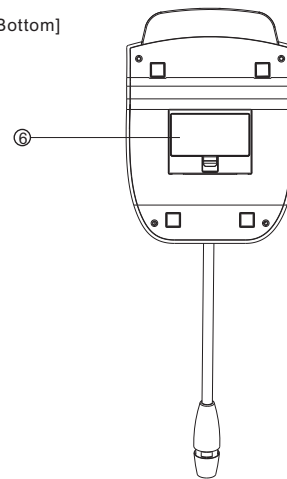

⑥AA battery compartment Install AA Battery in this compartment.

[Rear]

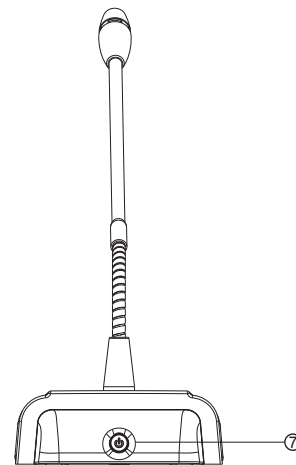

⑦Power switch: Press switch in 1 second to switch on the power, while in 3 seconds the power will be off.

04 Operation and Function Settings

4.1 Initiating System

Before turn on the Central Controller WDC-900M, please make sure every speaking unit is switched ON, and every Power indicator lights.

4.2 WDC-900M function Settings

4.2.1, Make sure every speaking unit is switched ON, then turn on WDC-900M, the system will search the Online users, and display on the LCD the ONLINE units. SPEAK units, REGISTERD units, IN LINE units and NO POWER units.

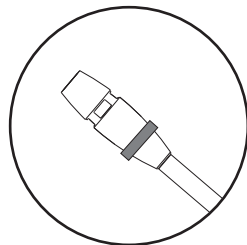
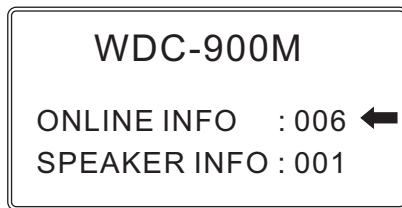

4.2.2, Or press "SEARCH" key, the system will automatically enter self test, then display the status on the LCD.

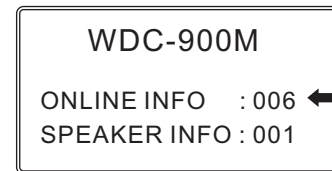
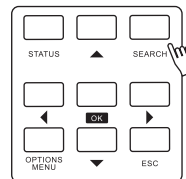

4.2.3, To check the display information are correct, then setup the other functions. If it is found the discrepancy, please double check every speaking unit is switched on, or restart the system for searching again.

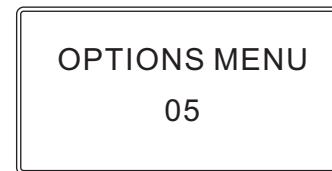
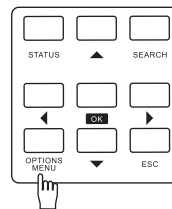

4.2.4. Press "OPOTION MENU" into main menu.

1), MODE,

Three operational microphone modes:

① IN TURN (with limited time): Allow one speaking unit only, and can set the microphone to open SPEAK TIME 0S to 999S, when the limited time is reach, subsequent microphone speaks. LCD on each unit shows "request list", "TIMER" and the limited speaking time.

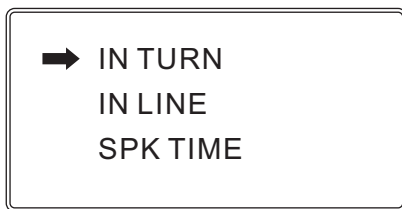
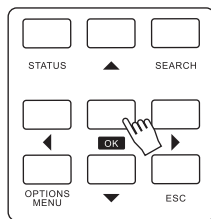

Press IN TURN to run this speak mode.
IN LINE show how many units are in this run.
SPK TIME to set the speak time for the delegate units.

② APPLY: The operation of delegate unit should be approved by chairman unit or operator, and just allow to open simultaneous 1 Chairman unit and 1 delegate unit

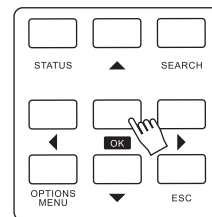

Press APPLY to run this speak mode.
APPROVAL shows YES or NO

I, Selecting "NO", the applying unit needs to be approved by Chairman unit within waiting time "APPLY SEC".
II, Selecting "YES", if there is no action from Chairman unit (approval or reject) within waiting time "APPLY SEC", operator setting admits that the applying unit is approved to speak.
APPD SEC to set the time in which delegated should be approved or not.

Chairman unit - The microphone always turns on, when there is a unit applying to speak, the LCD backlight is flashing, and displays "Requ" (requesting).

Delegate unit - When the unit is applying to speak, Letter "Idle" on LCD changes to "Requ" (requesting), and displays "wait". If approval, "wait" disappears, the LCD backlight flashes in 5 seconds and the microphone turns on; If reject, "wait" disappears, the LCD displays "NO", and the backlight flashes in 5 seconds.

③ FIFO: First-in / First-out priority: When the maximum number of speakers is reach, subsequent Talk key units with override of activated microphones.
LCD on each unit shows "active Mics" (active microphones) and the numbers of speaking units.

NOTE: The unit will turn off automatically in 10 seconds if it is outside the communications service area (no signal available).

4.2.5, REGISTER: All the discussion units can only be used after registered.
Please DEFAULT SET before register of any new speak units, and please note that the DEFAULT SET will delete all current system data such as your pre-set registered units, speak mode, speak time etc.

4.2.6, CHANNEL: Select channel by auto or manual.

4.2.7, LANG: Choose language. CHINESE OR ENGLISH

4.2.8, DEFAULT SET: To set the WDC-900M back to factory settings.

4.2.9, SQ: To change SQ level.

4.2.10, UNITS OFF: To turn off all the discussion units by one key.

4.2.11, UNIT OFF MODE:
1), ON: Selecting "ON", the discussion units still power on even the central controller turns off.
2), OFF: Selecting "OFF", the discussion units turn off while the central controller turns off.

4.2.12 SPEAKER: Display the numbers of speaking units.

NOTE: Any new settings only function after restart the WDC-900M central controller.

4.3, WDC-900M Menu Displays

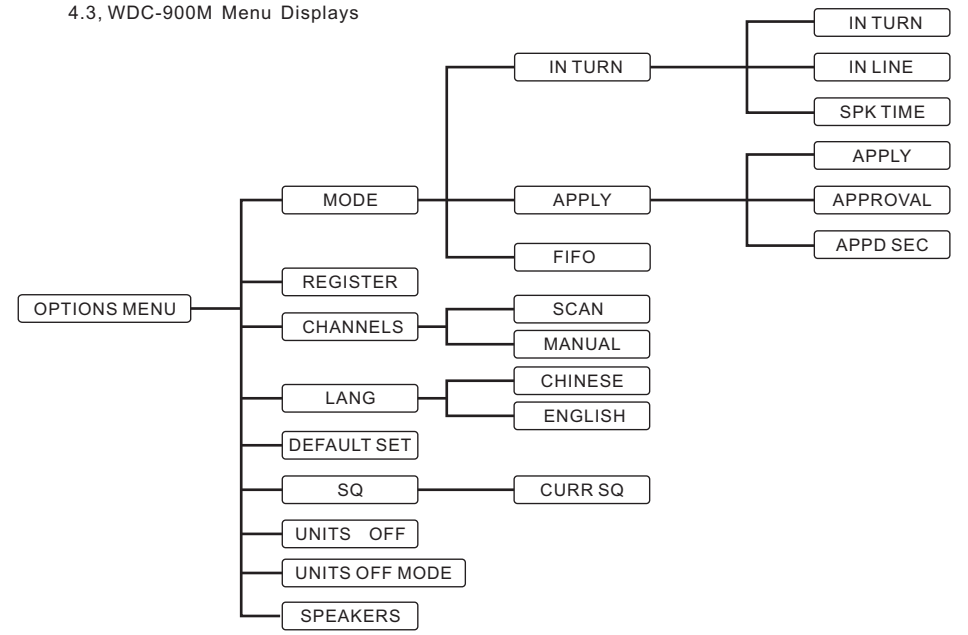

05 Optional for Automatic Video Tracking System VTS-1000

5.1 General Description

Video tracking system VTS-1000 cooperates with RELACART conference system: immediate display of speaker's image, appropriate for video recording. Unique frozen image and OSD functions ensure perfect automatic video tracking.

5.2 Features

- Rapid switch between several cameras and video signals.
- Control for up to 3 cameras.
- Unique frozen image function: any useless pictures will not be displayed (e.g. pictures caught by the camera's quick movement).
- OSD functions: display the information at the prearranged place.
- Compatible with cameras from different brands.

Front Panel

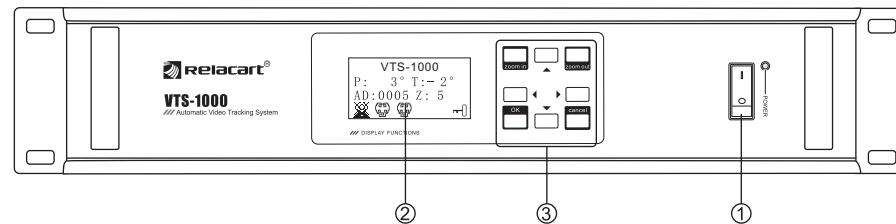

- ① Power Switch, setting this switch to the ON position cause the Power indicator to light.
- ② LCD displays operating status.
- ③ Operation keys.

Rear Panel

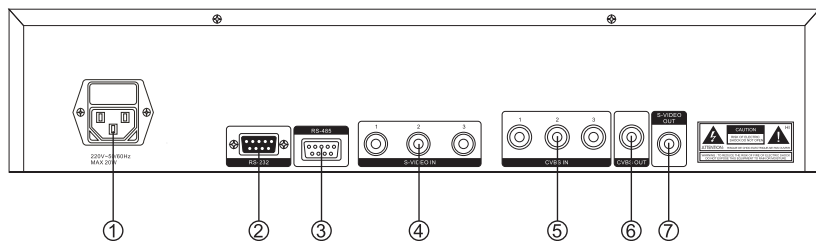

- ① Power Input: IEC type connector for 90V/240V 50/60Hz 20W without user adjustment.
- ② RS-232 Jack: Can be connected with RELACART conference system.
- ③ RS-485 Jack: Can be connected with camera.
- ④ S-VIDEO IN Input Jack: Can be connected with camera, and control for up to 3 cameras (Or optional for CVBS IN Input Jack).
- ⑤ CVBS IN Input Jack: Can be connected with camera, and control for up to 3 cameras.
- ⑥ CVBS OUT Output Jack: Can be connected with projector.
- ⑦ S-VIDEO OUT Output Jack: Can be connected with projector.

5.3VTS-1000 Functions Settings

5.3.1 Cooperates with WDC-1000M for Automatic Video Tracking

Step 1, To make sure every system is in the right connection, turn on every speaking unit, and VTS-1000, and then WDC-1000M.

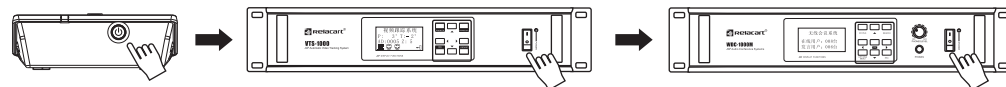

Step 2, WDC-1000M will automatically search the number of the online users and display on the LCD "ONLINE INFO".

WDC-1000M

ONLINE INFO : 006 ←
SPEAKER INFO : 001

Step 3, Press "OK" key on VTS-1000 to enter main menu, then touch ◀ / ▶ / ▲ / ▼ button to scroll through the available choice for "OPERATE", and "OK" key to confirm "TOTAL UNITS", the VTS-1000 will automatically search the number of online users and display on the LCD (this operation is to confirm the online user between VTS-1000 and WDC-1000M is the same, so that can proceed to the next step). If no difference is found, press "cancel" key, return to menu selection.

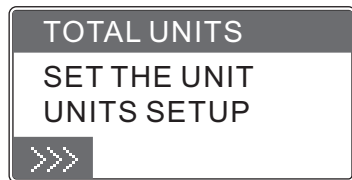
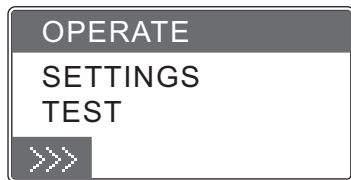

Step 4, Touch ◀ / ▶ / ▲ / ▼ button to scroll through the available choice for "UNITS SETUP: 001" and "TOTAL UNITS: XXX", press "OK" key for automatic camera tracking setup, and address "001" unit's microphone in-use indicator is flashing, touch ◀ / ▶ to adjust the camera to focus on the flashing microphone, then ▲ / ▼ key, or "zoom in" / "zoom out" to adjust the image, finally, press "OK" key to save the settings, and the system returns to the original interface "UNITS SETUP: 001" and "TOTAL UNITS: XXX".

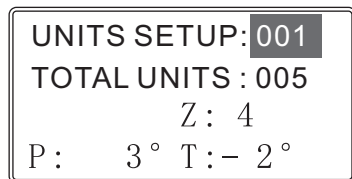

Step 5, Touch ▶ button for the next unit setup, and displays "UNITS SETUP: 002" press "OK" key for automatic camera tracking setup, and address "002" unit's microphone in-use indicator is flashing, touch ◀ / ▶ to adjust the camera to focus on the flashing microphone, then ▲ / ▼ key, or "zoom in" / "zoom out" to adjust the image, finally, press "OK" key to save the settings, and the system returns to the original interface "UNITS SETUP: 002" and "TOTAL UNITS: XXX".

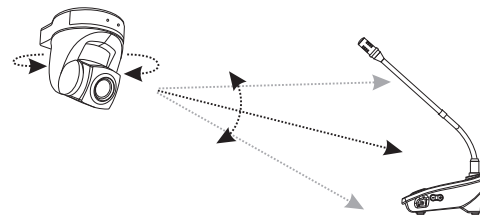
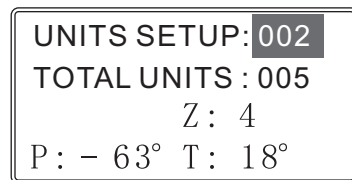

Step 6, Again touch ▶ button, repeat the settings as "Step 5", until you have got all units completed. You are recommended to start from "001" in order not to miss any unit.

Step 7, After completing all the units' settings, please press any unit' Talk Key to have a test, you will find the camera will automatically track the speaking unit, and display the image.

5.3.2, Functions Menu

Touch ◀ / ▶ / ▲ / ▼ button to scroll through the available choice for "OPERATE", "SETTINGS", "TEST" and "INFO".

◆ OPERATE

I, SET TRACKING: Enter this menu, operator can change the camera tracking manually. For example, if address 001 unit is speaking, you can set the camera to track other representatives, instead of 001 unit.

II, SAVE INFO: Enter this menu, operator can adjust the camera to track other image, and save to any address for the unit, when the unit presses the Talk Key, the camera will automatically track the image which has been saved.

III, TOTAL UNITS: Search the number of the online units.

IV, SET THE UNIT: Enter the menu, the system displays each unit's address, you can set the camera tracking accordingly.

V, UNITS SETUP: Starting from "001", you can set the camera tracking one by one.

◆ SETTINGS

I, INPUT FORMAT: Choose the video input, there is S-Video or CVBS available.

II, REVERSAL: There is "REVERSAL OFF" or "REVERSAL ON" available.

III, OUTPUT FORMAT: Choose the video output, there is S-Video or CVBS available.

IV, RESTORE SETTINGS: Can restore the "INPUT FORMAT" and "OUTPUT FORMAT" to default settings.

◆ TEST

Color bars: There are "COLOR BARS OFF" and "COLOR BARS ON" available, choose "COLOR BARS OFF", the camera will display image, but if choose "COLOR BARS on", the camera just display color bars.

◆ INFO

I, Facility

II, Standard

III, Edition

5.4 VTS-1000 Menu Displays

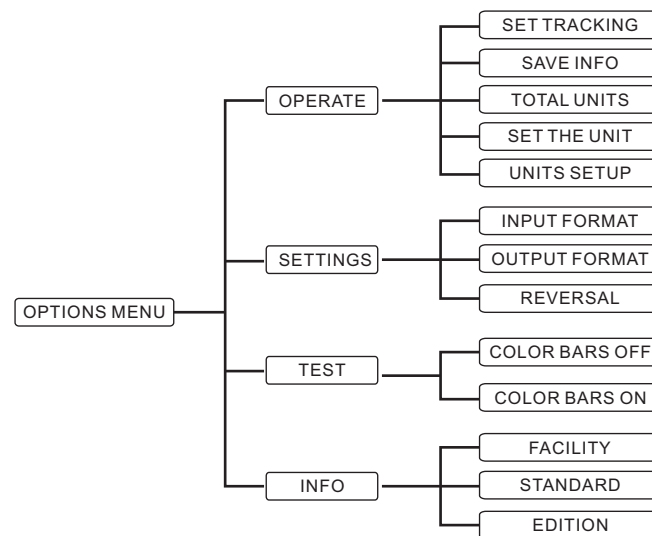

06 Installation and Connections

6.1, System Connection Examples

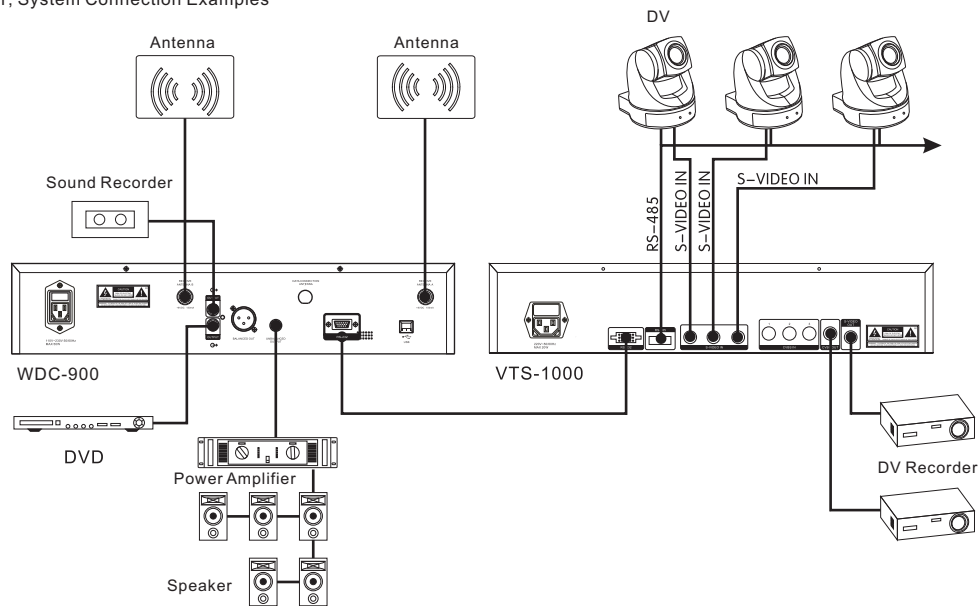

6.2, Notes on Installation of the Antennas

For better operation the antennas should be at least 6ft. (2m) above the ground and at least 3ft. away from a wall or metal surface to minimize reflections.

The antenna's transmitting power is 10mW, straight-line transmitting distance is 30m, it is recommended to install the antenna closed to the speaking units, instead of in the control room.

07 Accessories

6.3, Antennas Installation Examples

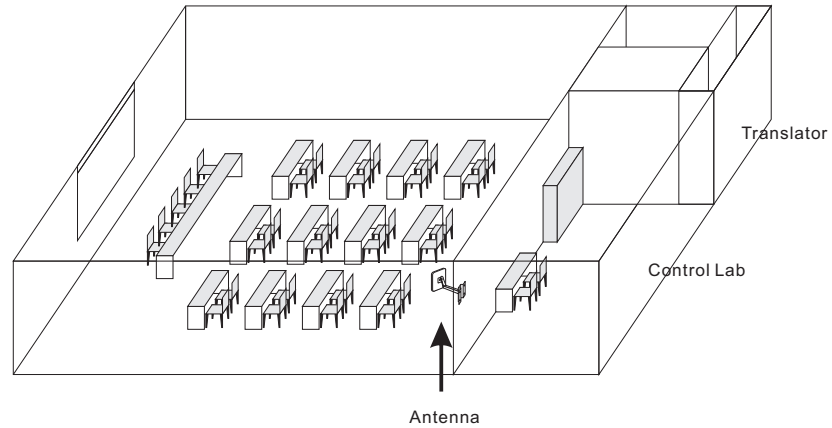

Install the antennas closed to the speaking units.

7.1, Antenna R-2.4C / R-2.4B

7.1.1 Transmitting distance can be up to 30m.

7.1.2, Stable functions, reliable and flexible performance, easy to install.

7.1.3, Can be fixed on the ceiling or by triangle bracket.

7.1.4, There is a coaxial cable between antenna and the central controller, the length of the coaxial cable is preferably less than 15m.

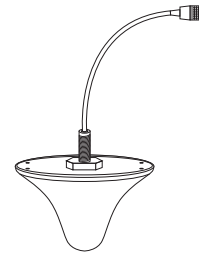

R-2.4C

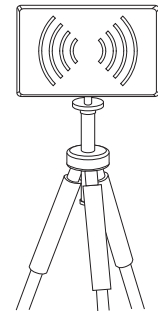

R-2.4B

7.2, Charging Case RC-10N / RC-20N

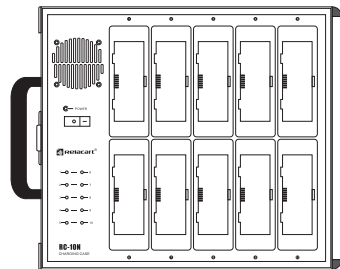
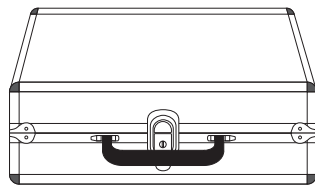

1. RC-10N is for 10pcs Ni-MH batteries, and RC-20N is for 20pcs Ni-MH batteries.
2. Separate charging status indicator for each battery, flashing means being charging.
3. Charging is completed within 5 hours and the charging status indicator lights red
4. Stop charging if batteries are not fully charged within 5 hours.
5. Switching the charger's power OFF and back ON again with fully-charged (charging completed) batteries inserted will result in repeated recharge of the batteries. Battery life could deteriorate from this repetitive charging.

7.3, Battery Installation

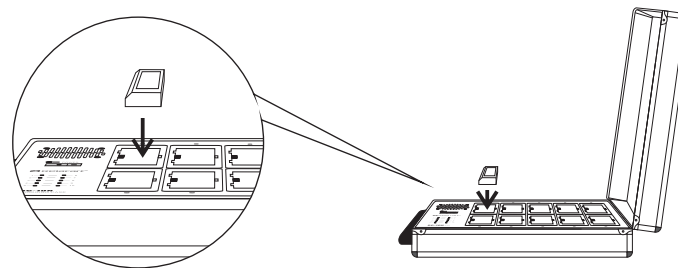

(legend 1)

7.4, Battery capacity indicator

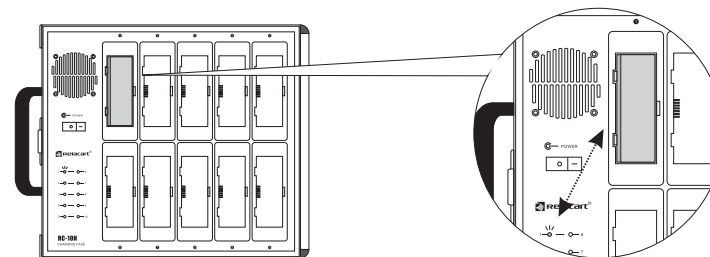

(legend 2)

08 Specifications

Digital and Wireless Discussion Conference System

WDC-900M	
Electrical	
Supply voltage	100V- 240V AC50/60 Hz
Power consumption	30W
Total supply power	60W
Frequency response	65Hz-18KHz(+0-3dB)
THD at nominal level	<0.9%
Dynamic range	>93dB
Signal-to-noiseratio	>98dBA
Audio Output	
XLR balance output	6 dBV(-24-6dBV)
6.3mm unbalance output	0 dBV
RCA max. output	-0 dBV
Mechannical	
Mounting	Tabletop or mounted in a 19" rack
Dimensions (H X W X D)	426(W) X 88(H) X 252(D)
Weight (KG)	4.3kg

WDC-900C & WDC-900D	
Electrical	
Frequency response	65Hz-18KHz
RF Output power	50mW
Mechanical	
Mounting	Tabletop
Dimension (H X W X D)	
without microphone	127(W) X 52(H) X 165(D)
Microphone length (selectable)	340MM / 420MM / 480MM
Weight(KG)	0.85KG
NO BATTERY INCLUDED	

Optional for Automatic Video Tracking System

VTS-1000	
Electrical	
Supply voltage	100V / 240V 0.5A, AC50/60 Hz
Power consumption	25W
To camera	3 pieces
Video output level	BNC 1.08V P-P
Video output impedance	75Ω
Video bandwidth	30MHz
AC output	0
Color	Black
Mounting	Tabletop or mounted in a 19" rack

Specifications

Models	R-2.4C	R-2.4B
Electrical		
Frequency range	1700-1900MHz	1700-1900MHz, 2400-2500MHz
VSWR	≤1.5	≤1.5
Input impedance	50Ω	50Ω
Gain	3-6dBi	16-22dBi
Polarization	Vertical	Vertical
Polar pattern	≥25dB	
Horizontal flap width	120°	360°
Vertical flap width	55°	55°
Max. power	150	150
Connector	BNC	BNC
Mechanical		
Dimensions (mm)	100mm (dia.)	300(L) X 300 (H) X 50 (D)
Weight	154G	874KG
Bracket		φ 50-100