

GENERAL CHARACTERISTICS

Nominal Overall Diameter	320	mm
Nominal Voice Coil Diameter	75	mm
Magnet Weight	360	g
Flux Density.....	1.22	T
Weight.....	3.90	Kg

THIELE-SMALL PARAMETERS

Voice Coil DC Resistance	R_E	3.14	Ω
Resonance Frequency	f_s	44.9	Hz
Mechanical Q Factor.....	Q_{MS}	11.13	
Electrical Q Factor.....	Q_{ES}	0.36	
Total Q Factor	Q_{TS}	0.35	
Mechanical Moving Mass	M_{MS}	87.0	g
Mechanical Compliance	C_{MS}	144	μm/N
Force Factor	$B \times l$	14.65	Wb/m
Equivalent Acoustic Volume.....	V_{AS}	57.6	lt.
Maximum Linear Displacement	X_{MAX}	+/-7.0	mm
Reference Efficiency	η_0	1.40	%
Diaphragm Area	S_D	530.9	cm ²
Losses Electrical Resistance.....	R_{ES}	97.3	Ω
Voice Coil Inductance @ 1kHz	L_E	0.84	mH

CONSTRUCTIVE CHARACTERISTICS

Magnet.....	Neodymium
Voice Coil Winding.....	Copper
Voice Coil Former.....	Fiberglass
Cone	Paper
Surround.....	Treated Cloth
Dust Dome	Solid Paper
Basket	Aluminium Die-Cast

ELECTRICAL CHARACTERISTICS

Nominal Impedance.....	4	Ω
Musical Power	700	W
Rated Power*	350	W
Sensitivity @ 1 W, 1 m	94.9	dB

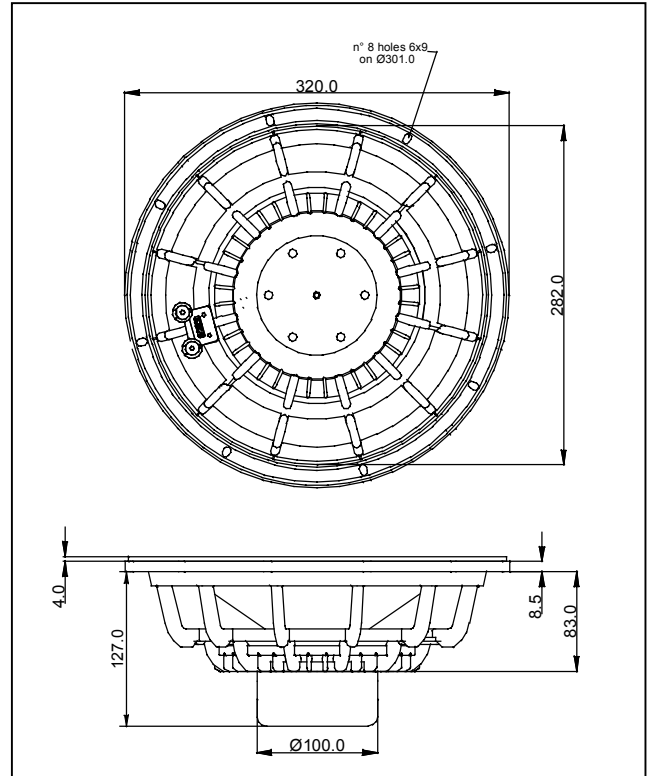

*rated power measured with 2 hours test with pink noise signal, 6 dB crest factor, loudspeaker mounted on enclosure
Thiele-Small parameters measured with LASER system

Frequency Response on IEC Baffle (DIN 45575) @ 1 W, 1 m - Impedance

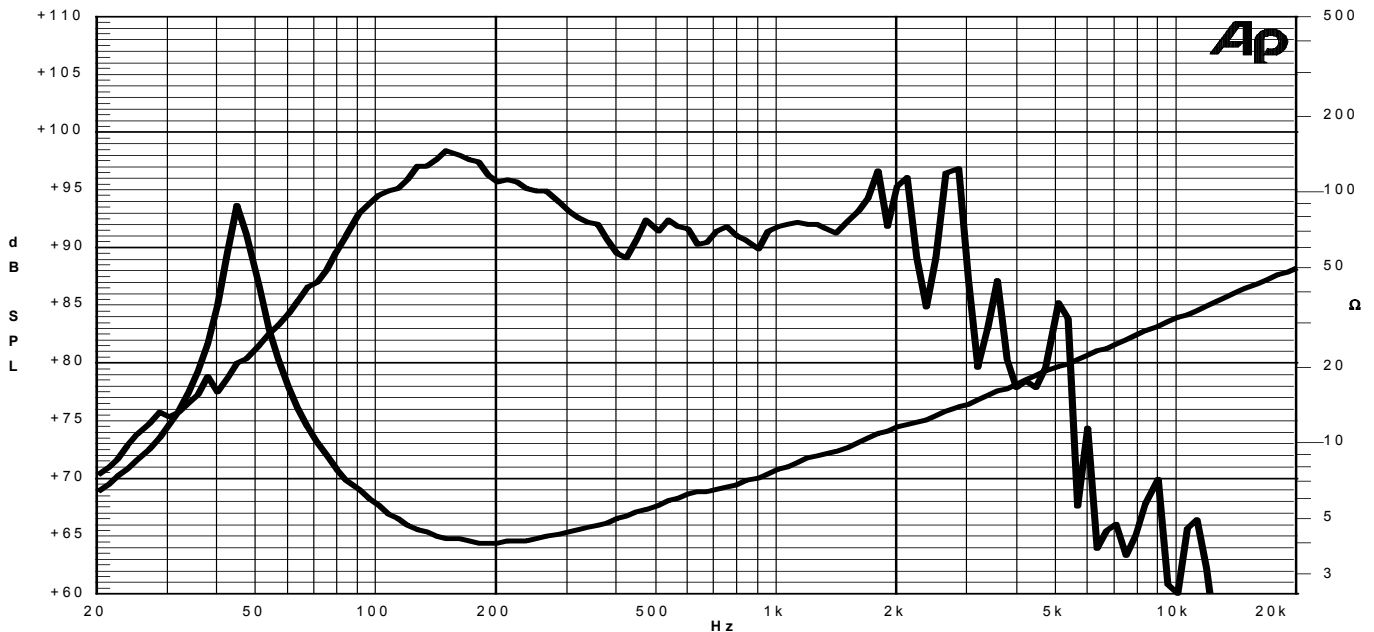

Due to continuing product improvement, the features and the design are subject to change without notice.

16/04/10