

15" - 700W Bass Guitar Loudspeaker

15 BS 3 PL - 8 Ω

Code Z008141

GENERAL CHARACTERISTICS

Nominal Overall Diameter	388	mm
Nominal Voice Coil Diameter	75	mm
Magnet Weight	360	g
Flux Density.....	1.17	T
Weight.....	4.00	Kg

THIELE-SMALL PARAMETERS

Voice Coil DC Resistance	R_E	5.06	Ω
Resonance Frequency	f_s	44.6	Hz
Mechanical Q Factor.....	Q_{MS}	7.64	
Electrical Q Factor.....	Q_{ES}	0.49	
Total Q Factor	Q_{TS}	0.46	
Mechanical Moving Mass	M_{MS}	80.9	g
Mechanical Compliance	C_{MS}	158	μm/N
Force Factor	$B \times l$	15.23	Wb/m
Equivalent Acoustic Volume.....	V_{AS}	163.1	lt.
Maximum Linear Displacement	X_{MAX}	+/-5.5	mm
Reference Efficiency	η_0	2.81	%
Diaphragm Area	S_D	855.3	cm ²
Losses Electrical Resistance.....	R_{ES}	78.1	Ω
Voice Coil Inductance @ 1kHz	L_E	0.78	mH

CONSTRUCTIVE CHARACTERISTICS

Magnet.....	Neodymium
Voice Coil Winding.....	Aluminium
Voice Coil Former.....	Kapton
Cone	Paper
Surround.....	Treated Cloth
Dust Dome	Solid Paper
Basket	Aluminium Die-Cast

ELECTRICAL CHARACTERISTICS

Nominal Impedance.....	8	Ω
Musical Power	700	W
Rated Power*	350	W
Sensitivity @ 1 W, 1 m	98.7	dB

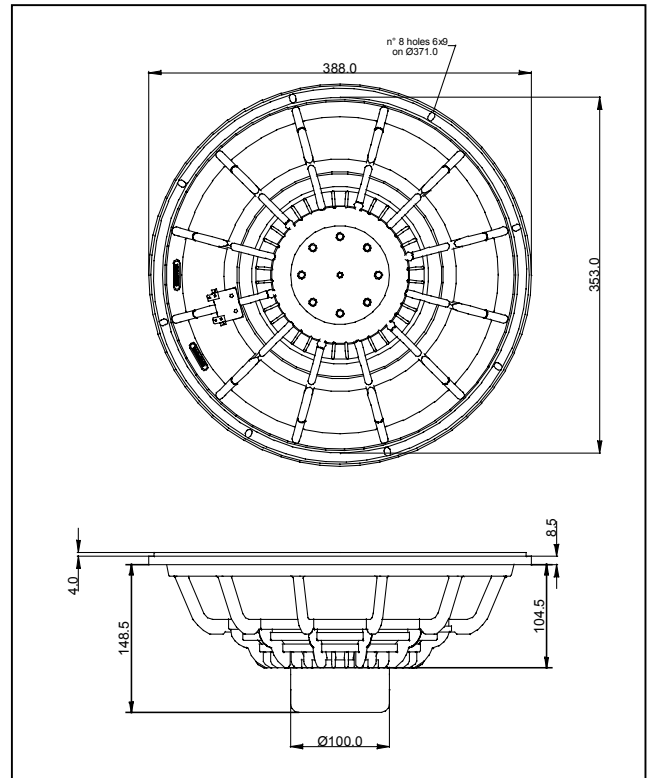

*rated power measured with 2 hours test with pink noise signal, 6 dB crest factor, loudspeaker mounted on enclosure
Thiele-Small parameters measured with LASER system

Frequency Response on IEC Baffle (DIN 45575) @ 1 W, 1 m - Impedance

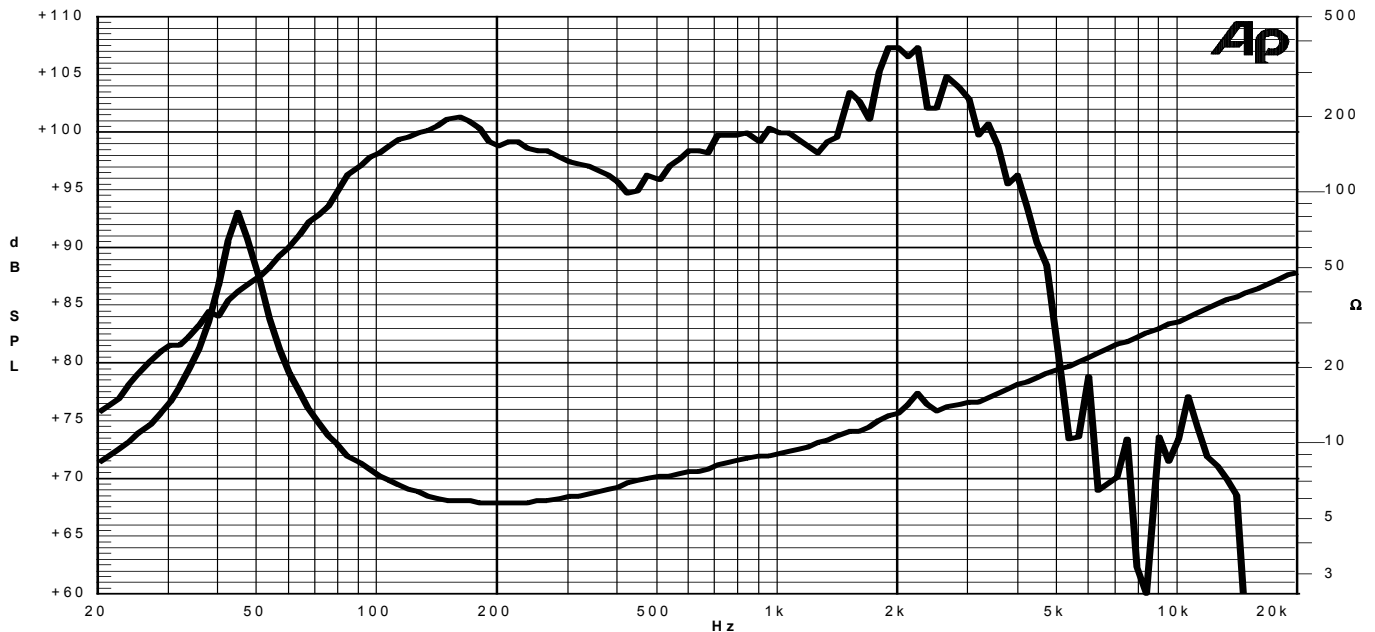

Due to continuing product improvement, the features and the design are subject to change without notice.

10/03/09

15 BS 3 PL

15" speaker – 3" voice coil

GRAPHICS AND MEASUREMENTS

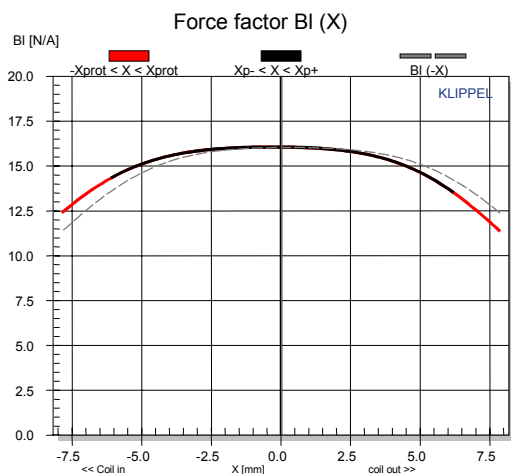

BI(X): force factor variation with voice coil displacement

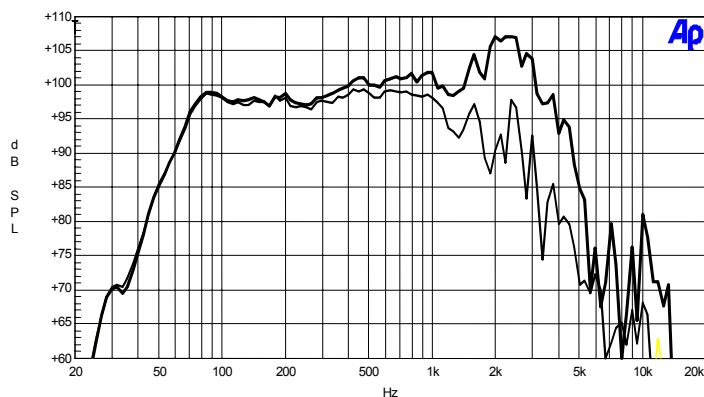

Frequency Response: enclosure volume 80l, port tuning 58Hz (thick curve on axis, thin curve 30° off axis)

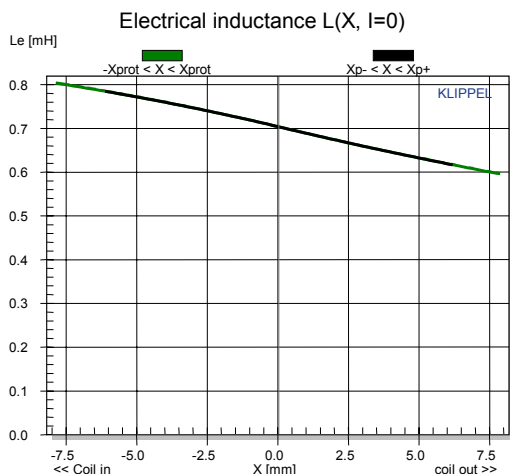

Le: electrical inductance variation with voice coil displacement

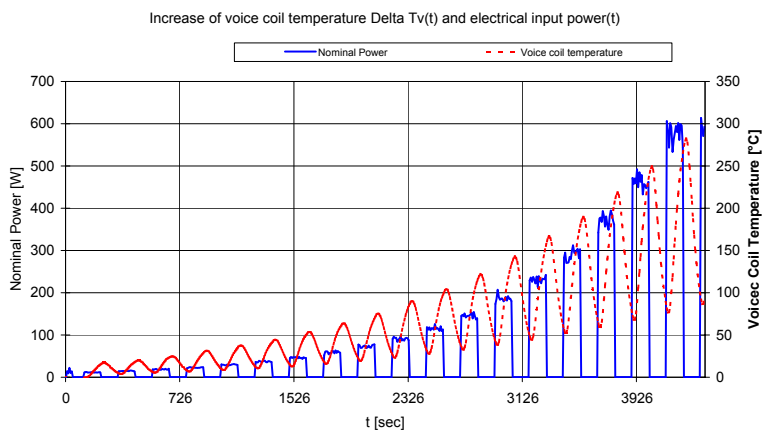

Power test done with intermittent excitation, ON interval 2min, duty cycle 50%, pink noise signal 6dB crest factor with frequency range 40-1000Hz.

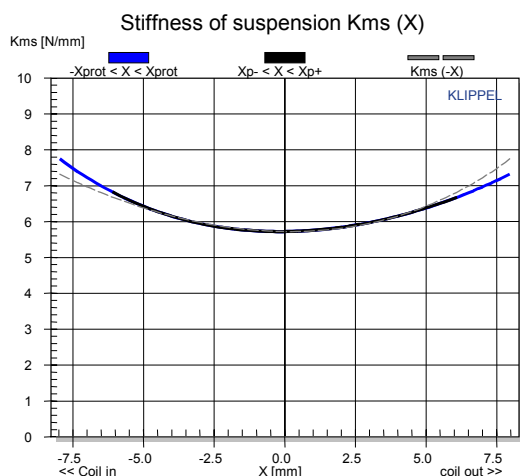

K_{ms}: stiffness of suspension variation with voice coil displacement

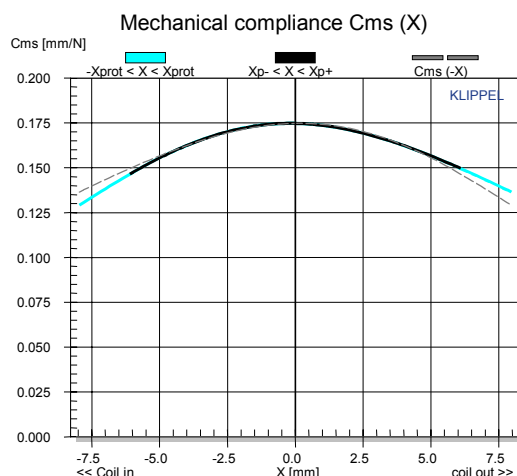

C_{ms}: mechanical compliance variation with voice coil displacement