

# PX 10 - 4 Ohm

Art. No. 4600

---



**10 cm (4") 2-Wege-Koaxiallautsprecher** mit Euro-Normkorb und Piezo-Hochtöner. Einfache Montage in Fahrzeugen mit Einbauorten für 10-cm-Lautsprecher. Wasserfeste Polypropylenmembran.

**10 cm (4") 2-way coaxial loudspeaker** with standard basket and piezoelectric tweeter. Straightforward installation in vehicles with cutouts for 10 cm speakers. Waterproof PP-cone.

## Anwendungsmöglichkeiten / Typical applications

- Fahrzeuge
- Reisemobile

- Vehicles
- Mobile homes

03.12.2013

### Eigenschaften / Attributes

- Polypropylenmembran
- Metallkorb
- Koaxiallautsprecher

- Polypropylene cone
- Metal basket
- Coaxial speaker

# PX 10 - 4 Ohm

Art. No. 4600

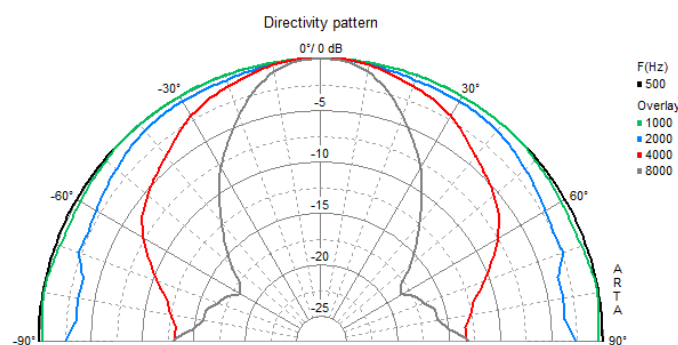
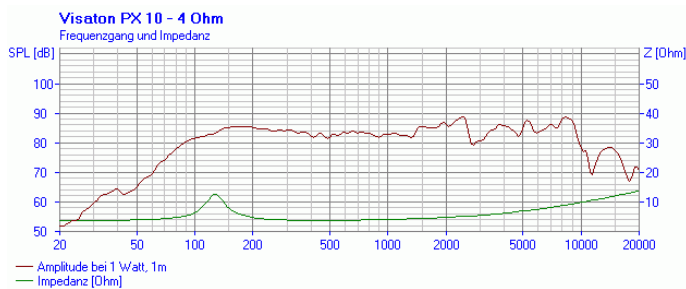
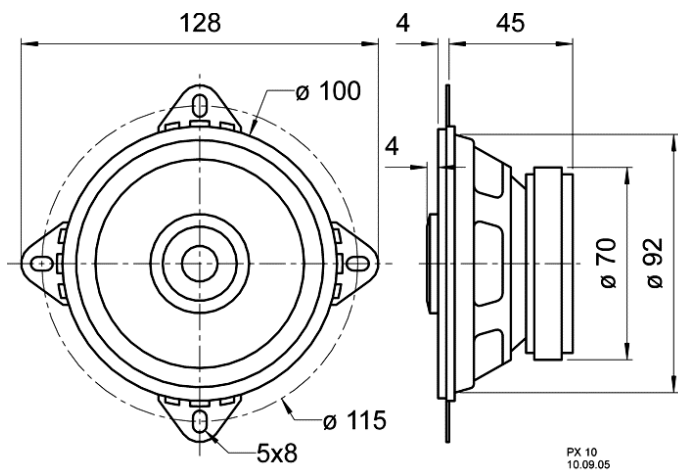

## Technische Daten / Technical data

Nennbelastbarkeit Rated power	20 W
Musikbelastbarkeit Maximum power	30 W
Nennimpedanz Z Nominal impedance Z	4 Ohm
Übertragungsbereich Frequency response	70–18000 Hz
Mittlerer Schalldruckpegel Mean sound pressure level	83 dB (1 W/1 m)
Abstrahlwinkel (-6 dB) Opening angle (-6 dB)	107°/4000 Hz
Grenzauslenkung Excursion limit	+/-2 mm
Resonanzfrequenz fs Resonance frequency fs	110 Hz
Obere Polplattenhöhe Height of front pole-plate	3 mm
Schwingspulendurchmesser Voice coil diameter	20 mm
Wickelhöhe Height of winding	5,2 mm
Schallwandöffnung Cutout diameter	93 mm
Gewicht netto Net weight	0,385 kg
Temperaturbereich Temperature range	-25 ... 70 °C

03.12.2013