

# AMS-24

AUDIO I/F for MUSIC & STREAMING

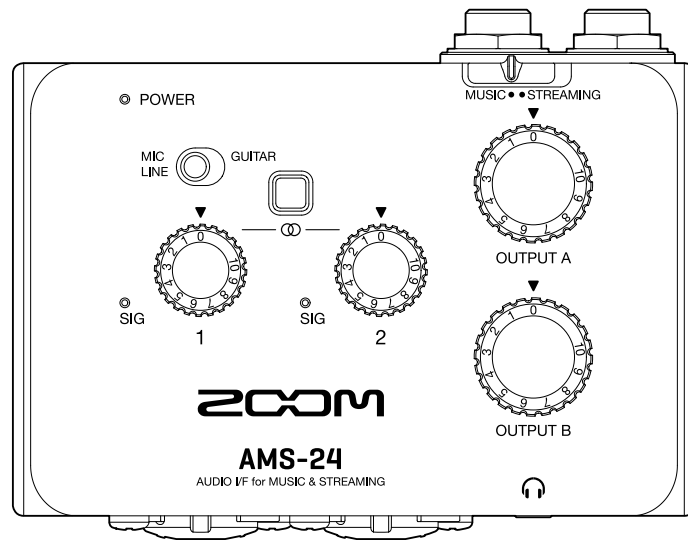

## Operation Manual

You must read the Usage and Safety Precautions before use.

©2022 ZOOM CORPORATION

Copying or reprinting this manual in part or in whole without permission is prohibited.

Product names, registered trademarks and company names in this document are the property of their respective companies. All trademarks and registered trademarks in this document are for identification purposes only and are not intended to infringe on the copyrights of their respective owners.

Proper display is not possible on grayscale devices.

# Notes about this Operation Manual

---

You might need this manual in the future. Always keep it in a place where you can access it easily. The contents of this document and the specifications of the product could be changed without notice.

- Windows® is a trademark or registered trademark of Microsoft® Corporation.
- Mac is a trademark of Apple Inc.
- Other product names, registered trademarks and company names in this document are the property of their respective companies.
- All trademarks and registered trademarks in this document are for identification purposes only and are not intended to infringe on the copyrights of their respective owners.
- Recording from copyrighted sources, including CDs, records, tapes, live performances, video works and broadcasts, without permission of the copyright holder for any purpose other than personal use is prohibited by law. Zoom Corporation will not assume any responsibility related to infringements of copyrights.

# Contents

---

Notes about this Operation Manual.....	2
Overview of MUSIC and STREAMING modes.....	4
MUSIC mode.....	4
STREAMING mode.....	5
Functions of parts.....	6
Top and bottom.....	6
Left and right sides.....	7
Front and back.....	8
Connecting to a computer.....	9
Installing the driver on Windows computers.....	10
Connecting smartphones and tablets.....	11
Supplying power.....	12
Connecting instruments and mics.....	14
Connecting instruments.....	14
Connecting mics.....	16
Stereo link overview.....	17
Adjusting the input gain.....	18
Using direct monitoring.....	19
Adjusting the volume.....	20
Adjusting OUTPUT A volume.....	20
Adjusting OUTPUT B volume.....	20
Enabling the loopback function.....	21
Use example: Making music.....	23
Use example: Web streaming using a computer.....	26
Use example: Web streaming using a smartphone/tablet.....	29
Mixer diagram.....	32
Terms used in this manual.....	33
Troubleshooting.....	34
Cannot select or use the AMS-24 device.....	34
The sounds of devices connected to input jacks are distorted, too quiet or silent.....	34
Cannot play or record.....	34
Playback sound cannot be heard or is quiet.....	35
Recorded audio is too loud, too quiet or silent.....	35
A smartphone or tablet cannot be used.....	35
Sound skips during playback or recording.....	35
Specifications.....	36

# Overview of MUSIC and STREAMING modes

Set this according to the use of the USB audio signal path.

## MUSIC mode

The MUSIC mode setting is good for making music with a DAW, for example.

Set  to MUSIC.

This mode is useful for recording a guitar and vocals simultaneously to separate tracks, for example. Input sounds are handled as separate signals by the computer, smartphone or tablet in the same way as with an ordinary audio interface.

Different sounds can be output from the computer, smartphone or tablet through headphone jacks A and B. This enables recording while a person operating the computer and a person performing listen to different sounds.

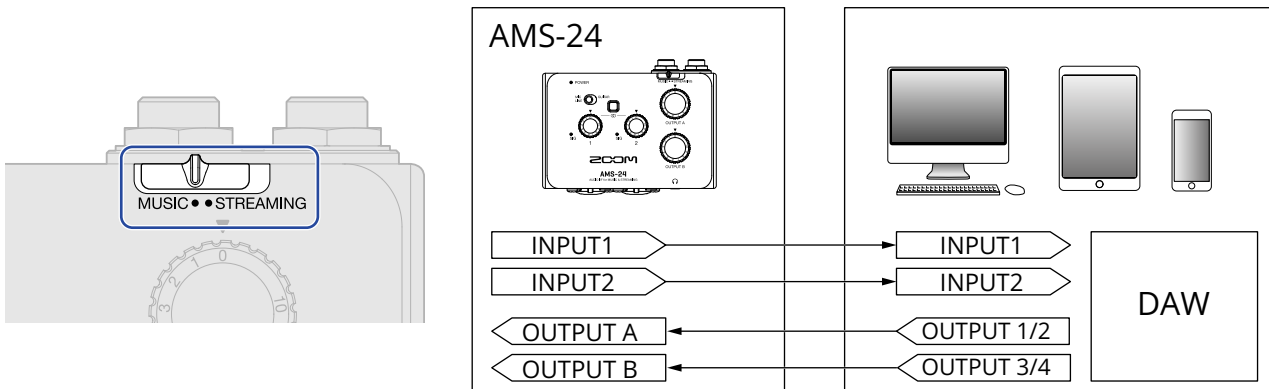

■ Use example

→ [Use example: Making music](#)

# STREAMING mode

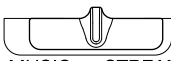
The STREAMING mode setting is good for web streaming. Set  to STREAMING.

This mode is useful for streaming solo performances of vocals accompanied by guitar, for example. Input sounds can be mixed like using an audio mixer and then sent to the computer, smartphone or tablet. Since the sound from the computer, smartphone or tablet (USB OUTPUT 1/2) is output from both OUTPUT A and B, this can also be used to record podcasts while two people monitor the same sound.

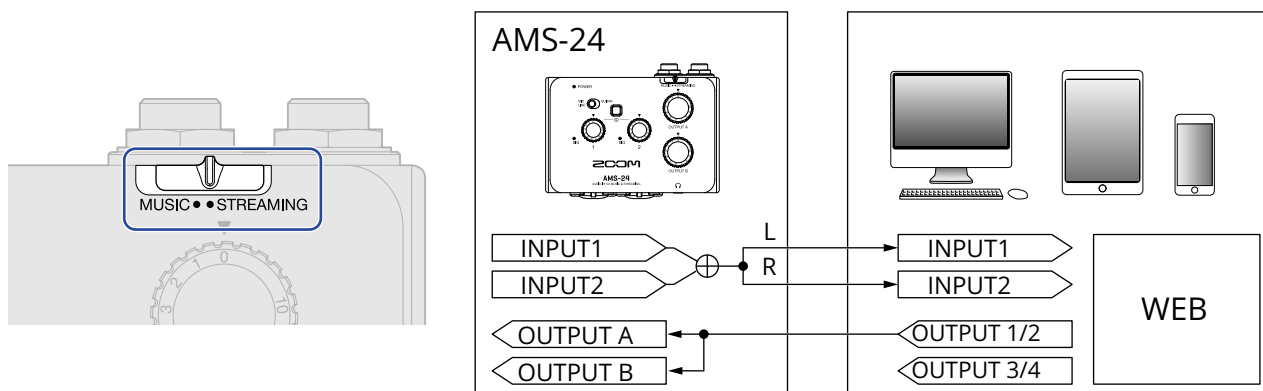

When the AMS-24 Stereo Link switch is on, Input 1 (left) and Input 2 (right) function as a stereo input. ([→ Stereo link overview](#))

## ■ Use examples

→ [Use example: Web streaming using a computer](#)

→ [Use example: Web streaming using a smartphone/tablet](#)

# Functions of parts

## Top and bottom

### ■ Top

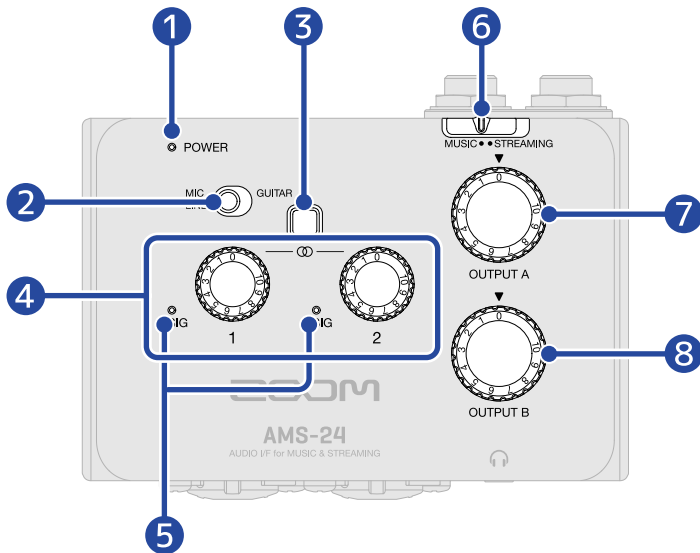

### ■ Bottom

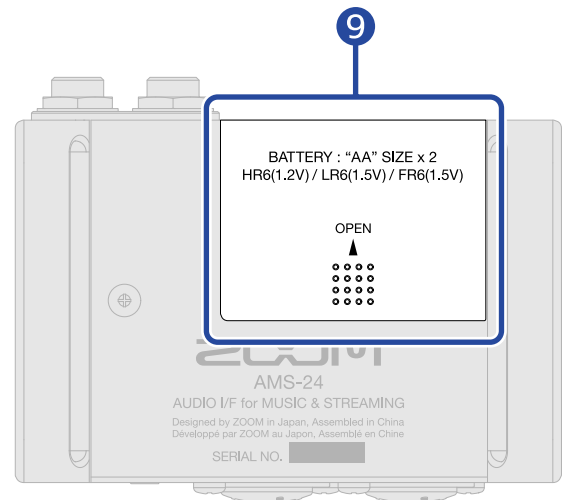

- 1 POWER indicator**  
This lights when the power is on. This blinks when the remaining battery charge is low.
- 2 Input type switch**  
Set this according to the equipment connected to Input 1.
- 3 Stereo Link switch**  
Turn this on when inputting a stereo signal through Inputs 1-2. Input 1 will become the left signal while Input 2 will become the right signal. When the Stereo Link switch is on, the input gain for both Inputs 1 and 2 is controlled by Gain knob 1. (→ [Stereo link overview](#))
- 4 Gain knobs**  
Use these to adjust input signal levels. (→ [Adjusting the input gain](#))
- 5 Level indicators**  
These indicators show signal levels after gain knob adjustment.  
The indicator colors change according to the signal levels.  
Lit green: Input signal is present. (-48 dBFS or higher)  
Lit red: Input signal is clipping. (-1 dBFS or higher)
- 6 MUSIC/STREAMING switch**  
This switches between MUSIC and STREAMING modes. Set it to MUSIC when using the AMS-24 to make music with a DAW, for example. Set it to STREAMING when using it to stream on the web, for example. (→ [MUSIC mode](#), [STREAMING mode](#))

## 7 OUTPUT A knob

Use this to adjust the volumes of signals output from the OUTPUT A standard phone jacks and the Headphone A jack. (→ [Adjusting OUTPUT A volume](#))

## 8 OUTPUT B knob

Use this to adjust the volume of signals output from the Headphone B jack. (→ [Adjusting OUTPUT B volume](#))

## 9 Battery cover

Slide this to remove it when loading batteries. (→ [Using batteries](#))

# Left and right sides

### Left side

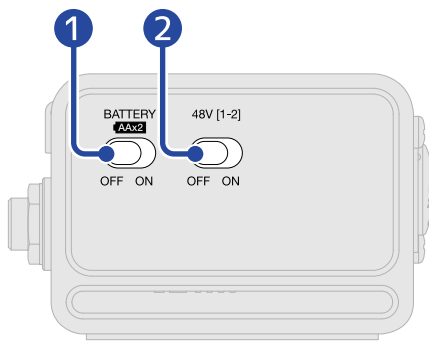

### Right side

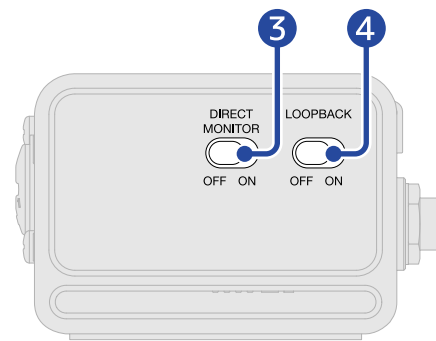

## 1 BATTERY switch

Set this to ON to use battery power. Set this to OFF to use USB bus power or an external power supply.

## 2 48V switch

This turns +48V phantom power ON/OFF. Set this to ON when connecting condenser mics. Phantom power is supplied to both inputs 1 and 2 simultaneously.

## 3 DIRECT MONITOR switch

Set this to ON to directly monitor sounds from the Input jacks before they pass through the computer. (→ [Using direct monitoring](#))

## 4 LOOPBACK switch

Set this to ON to send a mix of the sounds played by the computer and input through the AMS-24 back to the computer. (→ [Enabling the loopback function](#))

# Front and back

## ■ Front

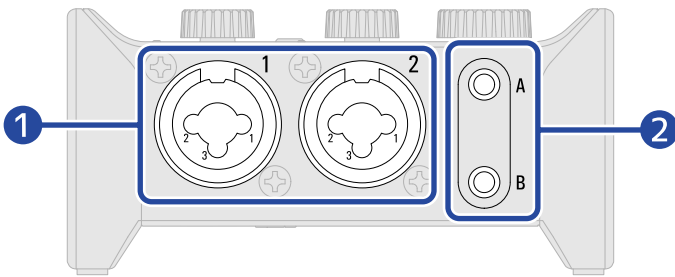

## ■ Back

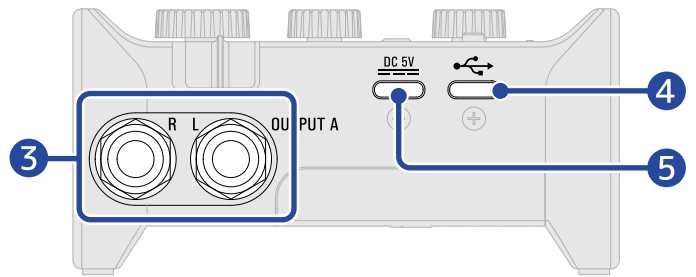

### 1 Input jacks 1-2

These input jacks have built-in mic preamps. Connect mics, keyboards, guitars and other audio sources to them. These can be used with both XLR and standard phone (balanced or unbalanced) plugs. (→ [Connecting instruments and mics](#))

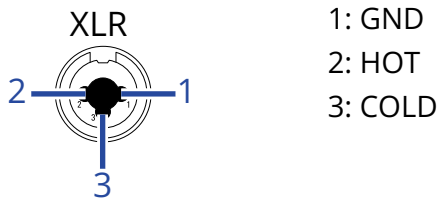

### 2 Headphone output jacks A-B

These output stereo signals. Connect headphones to these.

### 3 OUTPUT A standard phone jacks

These output the left (L) and right (R) channels of stereo signals. Connect these to speakers with built-in amplifiers, for example.

### 4 USB port (Type-C)

Use this USB port to connect computers, smartphones and tablets. (→ [Connecting to a computer](#), [Connecting smartphones and tablets](#))

### 5 DC 5V port (Type-C)

Use this power supply USB port to connect an AC adapter or mobile battery. (→ [Using an external power supply](#))



# Connecting to a computer

The AMS-24 is compatible with USB bus power, so power can be supplied to it from a computer through a USB cable. In addition to USB bus power, it can also be operated using an external power supply (dedicated AC adapter or mobile battery) or batteries. (→ [Using an external power supply](#), [Using batteries](#))

1. Install the dedicated driver before using an AMS-24 to record for the first time with a DAW application on a Windows computer. (→ [Installing the driver on Windows computers](#))

**NOTE:**

A driver is not necessary when using a Mac.

2. Minimize the volume before connecting speakers, headphones or other output devices to the AMS-24. (→ [Adjusting the volume](#))

3. Use a USB cable to connect the AMS-24 USB port (Type-C) to a USB port on the computer.

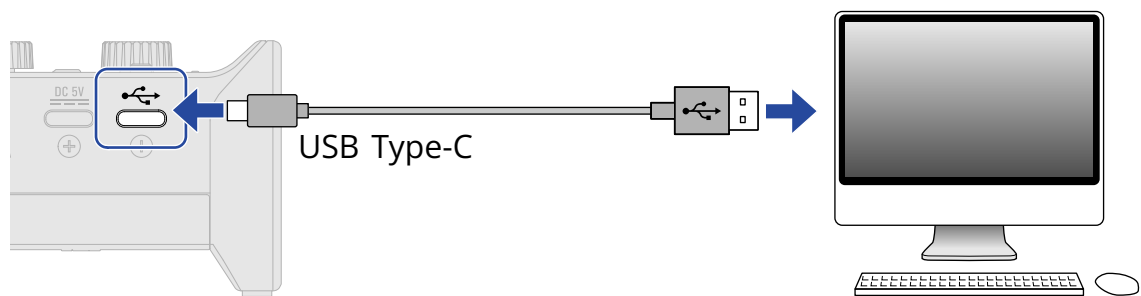

**NOTE:**

Use a USB cable that supports data transfer.

4. To use USB bus power, set **BATTERY AAx2** to OFF.

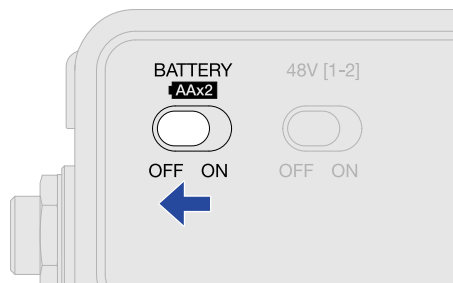

5. Confirm that the POWER indicator is lit red.

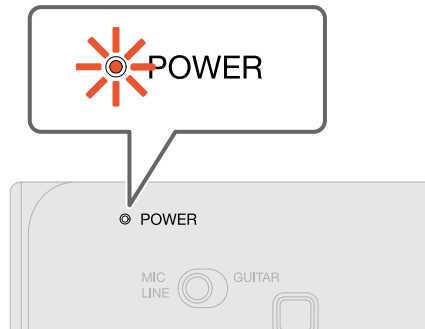

## Installing the driver on Windows computers

The dedicated driver must be installed on a Windows computer before using a DAW app on it to record.

1. Download the "ZOOM AMS-24 Driver" from [zoomcorp.com](http://zoomcorp.com) to the computer.

**NOTE:**

The latest "ZOOM AMS-24 Driver" can be downloaded from the above website.

2. Launch the installer and follow the instructions to install the "ZOOM AMS-24 Driver".

**NOTE:**

- Do not connect the AMS-24 to the computer during installation.
- See the Installation Guide included in the driver package for detailed installation procedures.

# Connecting smartphones and tablets

During use with a smartphone or tablet, an external power supply or batteries must be used.

1. Minimize the volume before connecting speakers, headphones or other output devices to the AMS-24. (→ [Adjusting the volume](#))
2. Connect an external power supply or use batteries. (→ [Using an external power supply](#), [Using batteries](#))

**NOTE:**

Power must be provided before connecting a smartphone or tablet to the AMS-24.

3. Use a USB cable to connect the AMS-24 USB port (Type-C) to the smartphone/tablet.

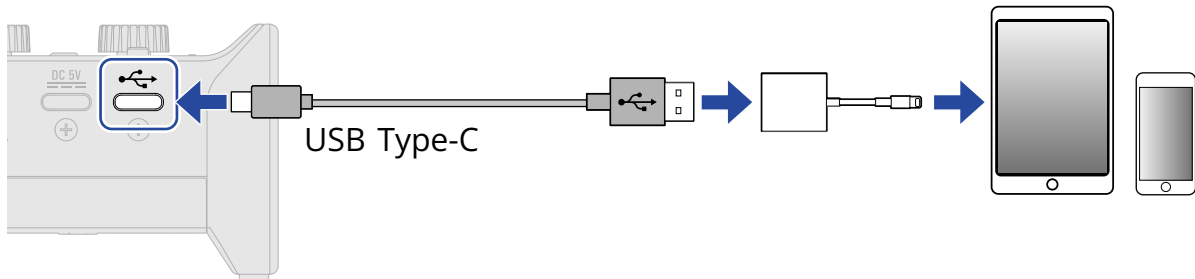

To connect smartphones and tablets, prepare USB cables and adapters that match their connectors as necessary.

Use a USB cable that supports data transfer.

Connector type	Necessary USB cable/adaptor
Lightning connector	USB Type-A to Type-C cable, Lightning to USB 3 Camera Adapter
Type-C connector	USB Type-C to Type-C cable

# Supplying power

## Using an external power supply

A dedicated AC adapter (ZOOM AD-17) or a commercially-available USB mobile battery can be used.

1. Connect the USB connector of the dedicated AC adapter to the DC 5V port (Type-C), and plug the AC adapter into an outlet.

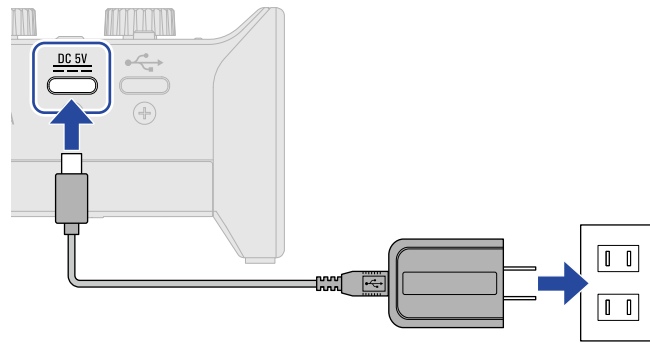

### HINT:

To use a USB mobile battery, connect its USB cable to the DC 5V port (Type-C).

2. Set  to OFF.

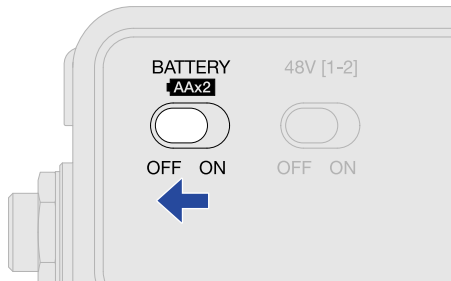

3. Confirm that the POWER indicator is lit red.

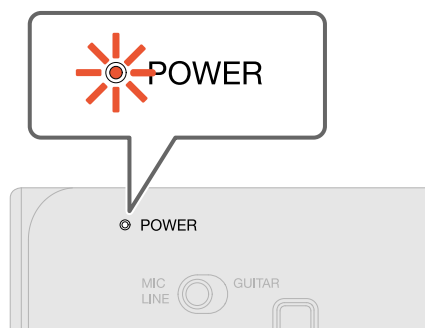

# Using batteries

Prepare two AA batteries.

1. Slide open the battery cover on the bottom of the AMS-24 and install the batteries.

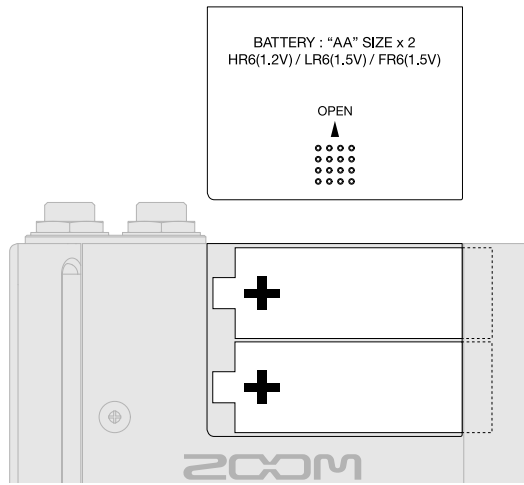

2. Slide the battery cover to close it.

3. Set **BATTERY** **AAx2** to ON.

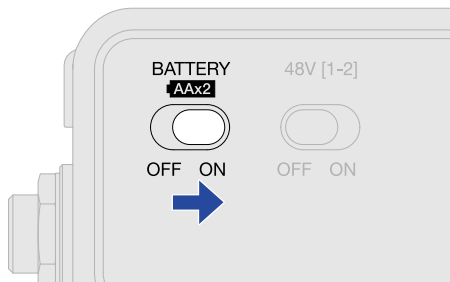

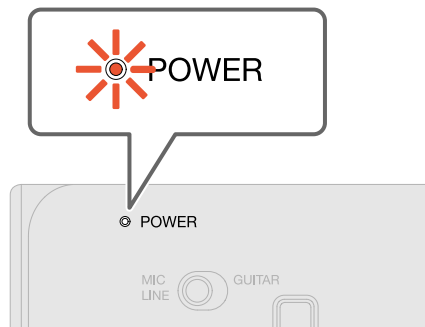

4. Confirm that the POWER indicator is lit red.



## NOTE:

- Use only one type of battery (alkaline, NiMH or lithium) at a time.
- The POWER indicator will blink when the battery charge becomes low. Replace the batteries with new ones.

# Connecting instruments and mics

Always set  to 0 and  48V[1-2] to OFF before connecting instruments and mics.

## Connecting instruments

### 1. Connect an instrument to the AMS-24.

- Use an instrument cable to connect a guitar or bass, for example, to the Input 1 jack.

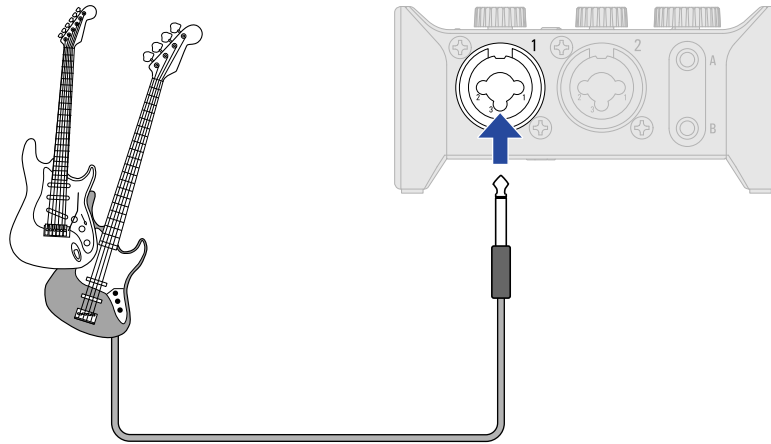

- Use instrument or TRS cables to connect a keyboard, or mixer, for example, to the Input 1-2 jacks.

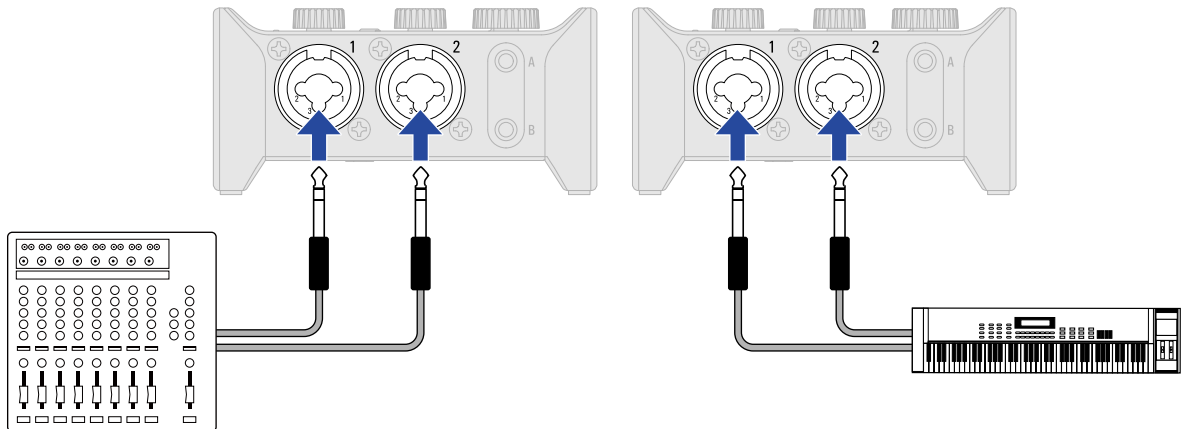



2. Set  according to the device connected to the Input 1 jack.

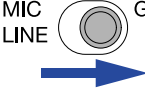
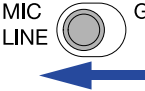

Switch position	Explanation
	Use this setting when connecting a passive guitar or bass. Set this to GUITAR to support high-impedance (Hi-Z) input. This does not need to be set to GUITAR when connecting an active guitar or bass.
	Use this setting when connecting a mic or keyboard, for example.

**NOTE:**

- Phantom power (48 V) is only supplied to the XLR connectors.
- When  is set to GUITAR, phantom power (48 V) to the Input 1 jack is disabled. When connecting a condenser mic to the Input 1 jack and using phantom power (48 V), set  to MIC/LINE.

3. When connecting a keyboard or other equipment with stereo output, set the Stereo Link switch to ON. (→ [Stereo link overview](#))

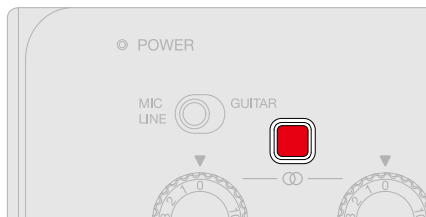

# Connecting mics

1. Use mic cables to connect dynamic and condenser mics to the Input 1 and 2 jacks.

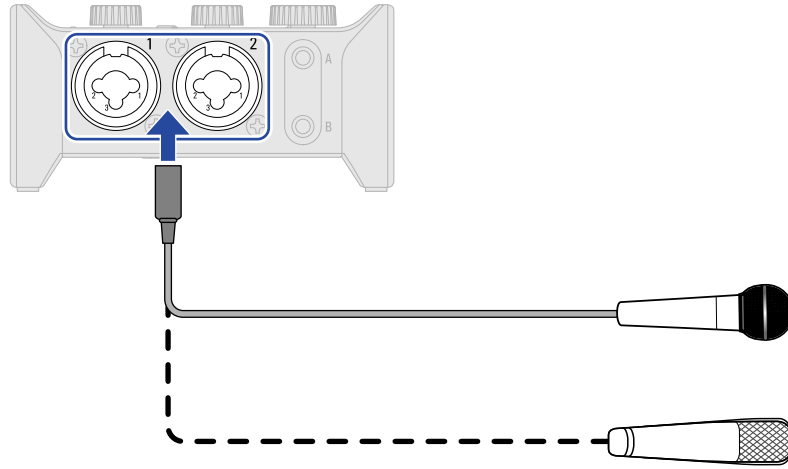

2. When connecting a mic to the Input 1 jack, set  $\begin{matrix} \text{MIC} \\ \text{LINE} \end{matrix}$   to MIC/LINE.

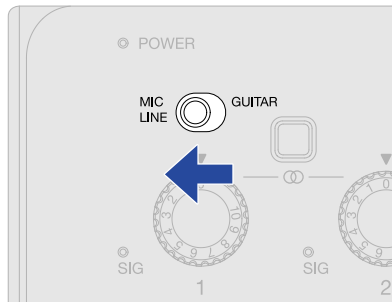

3. Use  $\begin{matrix} 48\text{V}[1-2] \\ \text{OFF} \text{ ON} \end{matrix}$  to set phantom power.

Phantom power is supplied to the XLR connectors of both Inputs 1 and 2 simultaneously.

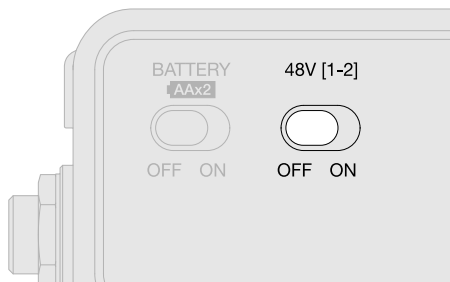

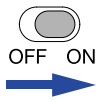
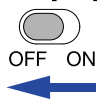
Switch position	Explanation
48V [1-2]  OFF ON	Use this to supply phantom power to condenser mics.
48V [1-2]  OFF ON	Use this when connecting dynamic mics.



**NOTE:**

Do not set 48V(1-2) to ON when connecting equipment that is not compatible with phantom power. Doing so could damage the equipment.

## Stereo link overview

Turning on the stereo link enables stereo input with sound from Input 1 to the left and Input 2 to the right. When connecting a keyboard or other equipment with stereo output, set the Stereo Link switch to ON.

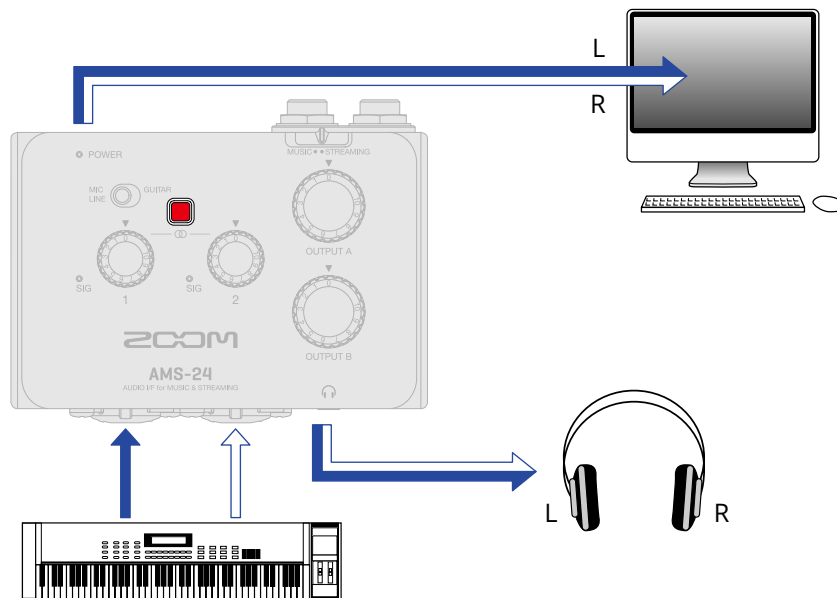

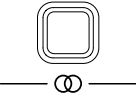
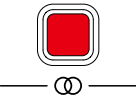
Switch status	Direct monitoring and USB Inputs 1/2 (when in STREAMING mode)
OFF 	Inputs 1 and 2 are mono. L: Inputs 1 and 2 R: Inputs 1 and 2
ON 	Inputs 1 and 2 are stereo. L: Input 1 R: Input 2

**NOTE:**

When the Stereo Link switch is on, the input gain for both Inputs 1 and 2 is controlled by Gain knob 1. (→ [Adjusting the input gain](#))

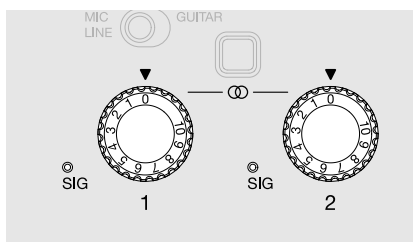

# Adjusting the input gain

The input sensitivity of Inputs 1–2 can be adjusted.



1. Use  to adjust the input signals while inputting sound from instruments and mics.

Level indicators

-  : Input signal present ( $-48$  dBFS or higher).
-  : Input signal is clipping ( $-1$  dBFS or higher).

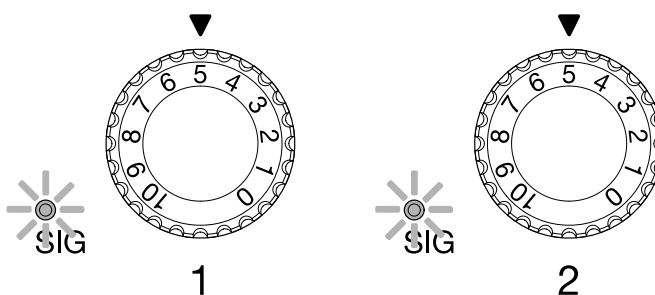

## NOTE:

- Set these so that their level indicators do not light red.
- To minimize noise, set the gain for any input jack not being used to 0.
- When the Stereo Link switch is on, the input gain for both Inputs 1 and 2 is controlled by Gain knob 1. (→ [Stereo link overview](#))

# Using direct monitoring

When direct monitoring is turned on, sound input to the AMS-24 can be directly monitored using headphones, for example, before it passes through the computer. This enables monitoring without latency.

1. Set  to ON.

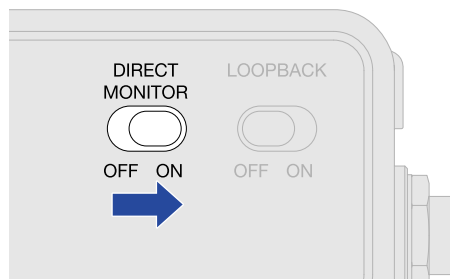

---

## HINT:

When the Stereo Link switch is on, sounds from Inputs 1 and 2 can be monitored in stereo. (→ [Stereo link overview](#))

---

# Adjusting the volume

The volume output from speakers and headphones connected to the AMS-24 can be adjusted. The connected jacks have different knobs to adjust their volumes.

**NOTE:**

Set the AMS-24 volume to 0 before connecting speakers or headphones. Failure to do so could result in unexpected loud sounds, causing harm to hearing, for example.

## Adjusting OUTPUT A volume

Turn  to adjust the volume for the Headphone A output jack on the front of the unit and OUTPUT A standard phone jacks on the back of the unit.

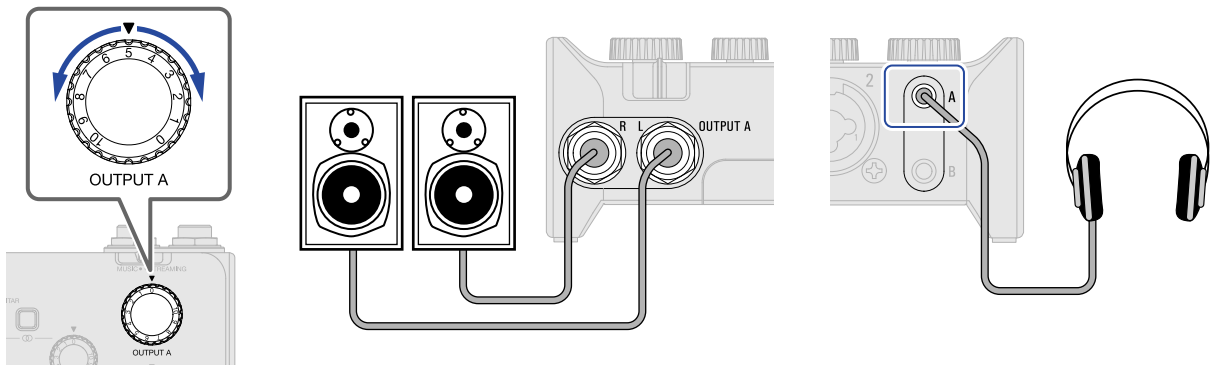

## Adjusting OUTPUT B volume

Turn  to adjust the volume for the Headphone B output jack on the front of the unit.

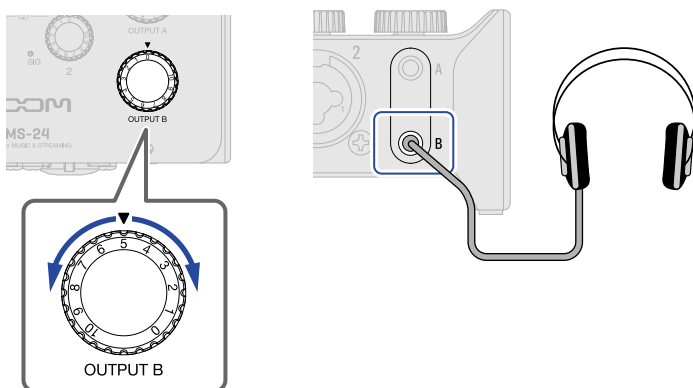

# Enabling the loopback function

By turning the LOOPBACK function ON, sound input through the AMS-24 Input 1–2 jacks and sound output from the computer can be mixed and then input to the computer again (looped back).

This is convenient for mixing background music played on the computer with sound input through the AMS-24 and streaming it live, for example.

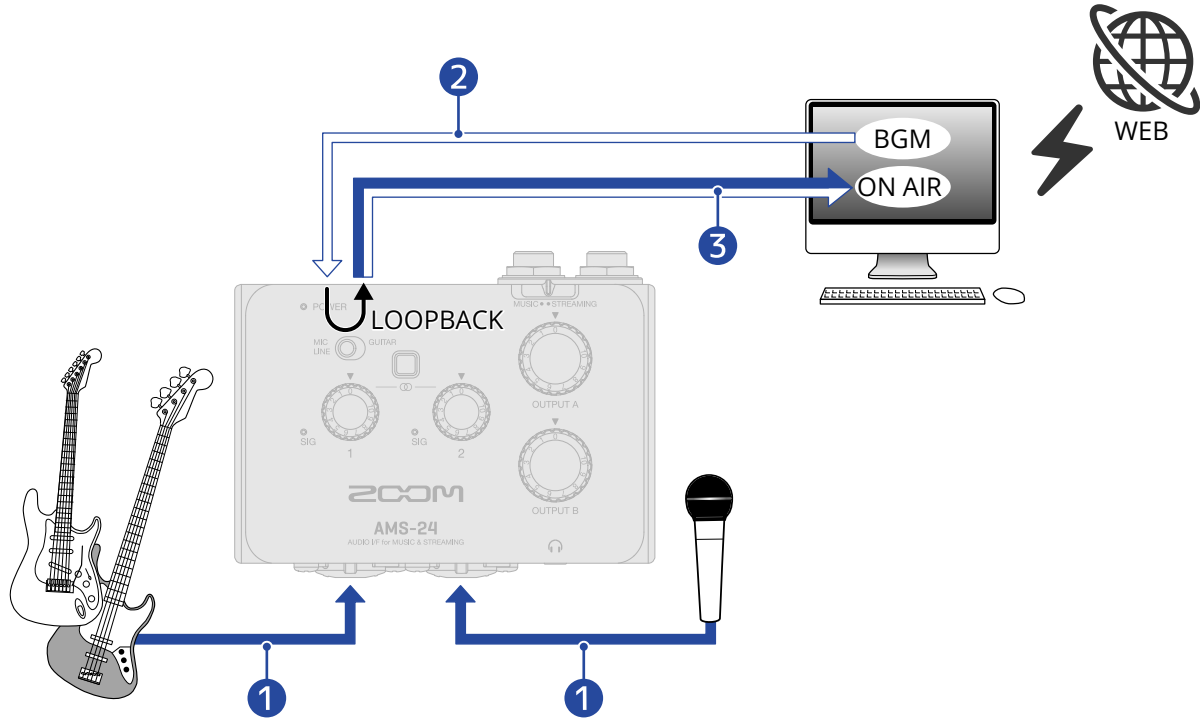

- 1 Mic and instrument sounds are input to the AMS-24.
- 2 BGM from the computer is input to the AMS-24.
- 3 The mic and instrument sounds and the BGM from the computer are mixed and output to the computer.

1. Set  LOOPBACK to ON.  
OFF ON

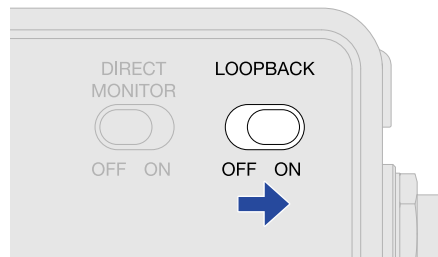



**NOTE:**

- When  is set to ON, disable AMS-24 monitoring in the DAW or streaming application.  
If enabled, a feedback loop could be generated, which might cause loud noise to be output.
- The USB OUTPUT 3/4 sound will not be looped back.

# Use example: Making music

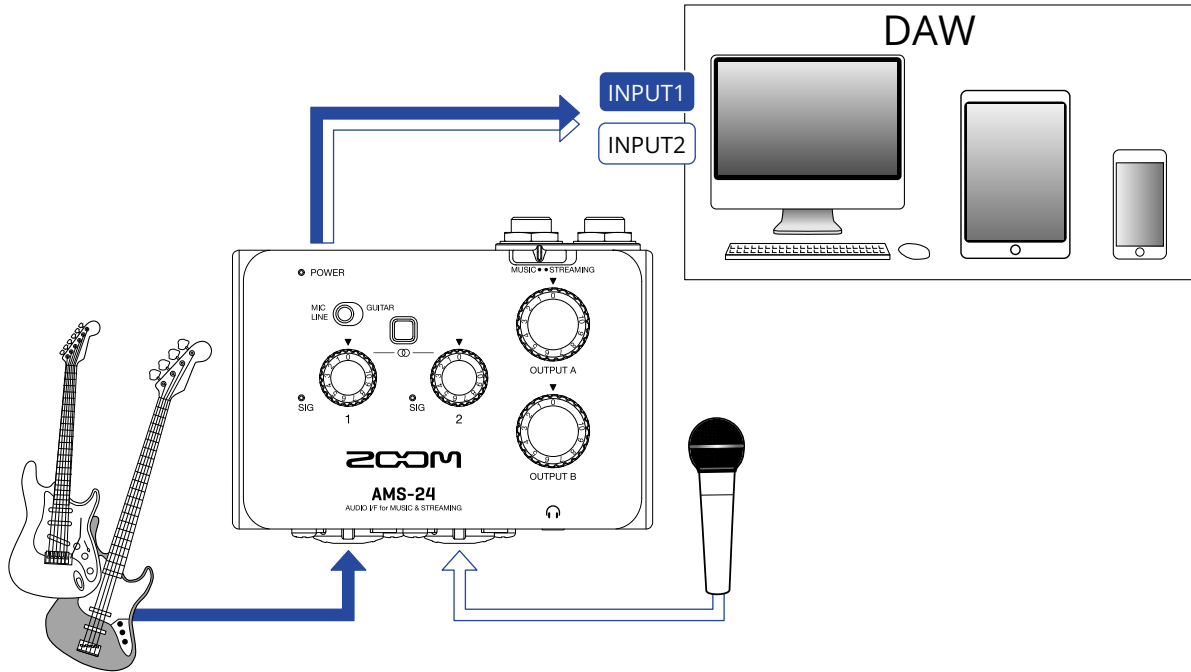
To make music using a DAW app to record guitar and vocals at the same time, for example, set the AMS-24 to MUSIC mode. The audio from the guitar and vocals can be recorded to separate tracks.



1. Set  to MUSIC mode. (→ [MUSIC mode](#))

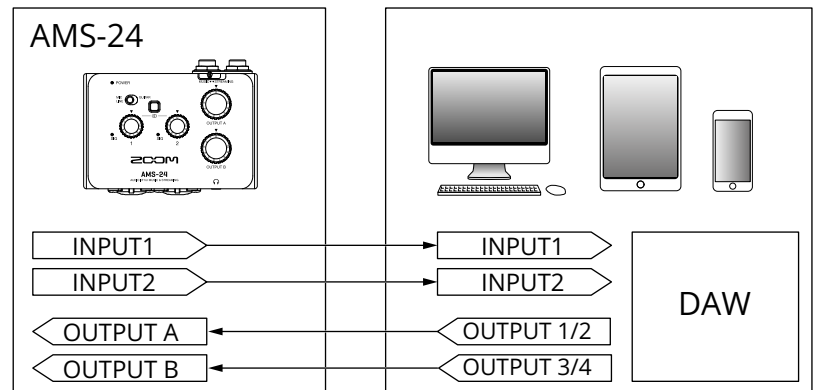
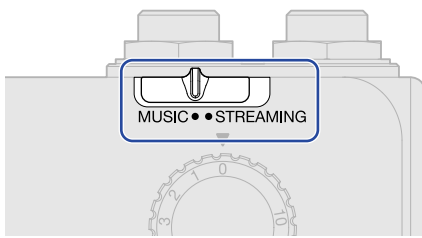

2. Supply power if using a smartphone or tablet. (→ [Supplying power](#))

## NOTE:

Power must be provided before connecting a smartphone or tablet to the AMS-24.

- 3.** Connect the AMS-24 and the computer, smartphone or tablet. (→ [Connecting to a computer](#), [Connecting smartphones and tablets](#))

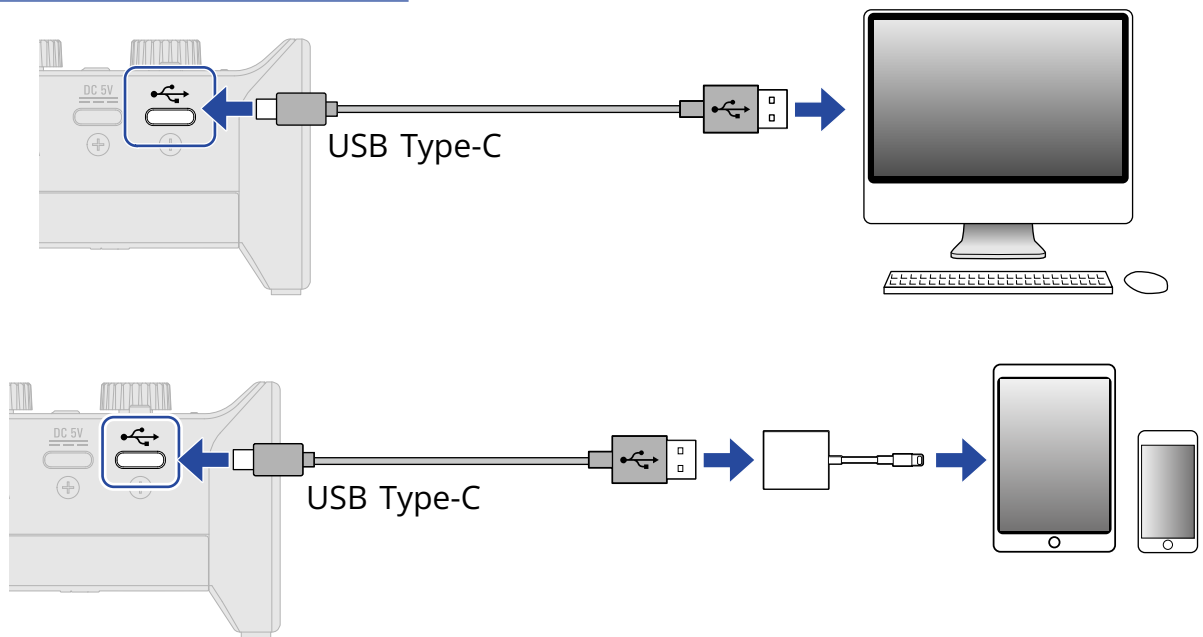

- 4.** Connect the mic and instrument and set the switches. (→ [Connecting instruments](#), [Connecting mics](#))

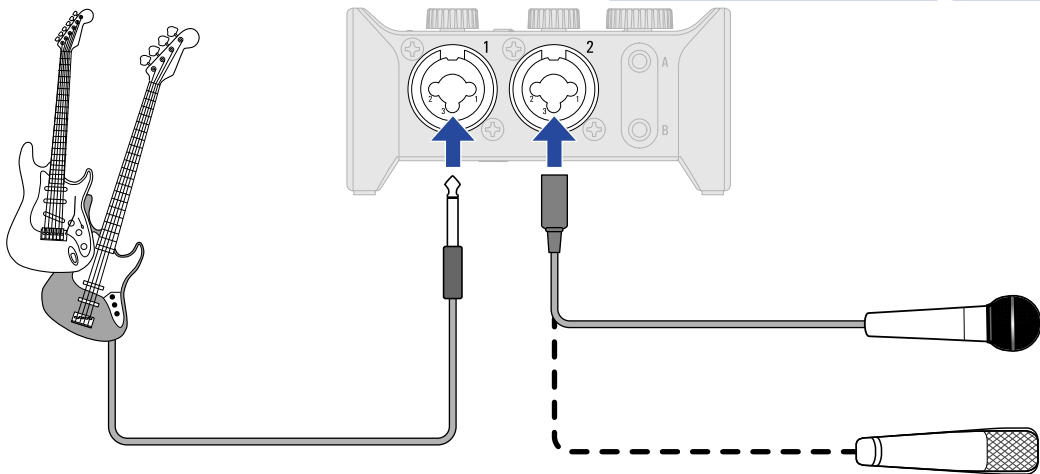

- 5.** Adjust the input gain. (→ [Adjusting the input gain](#))

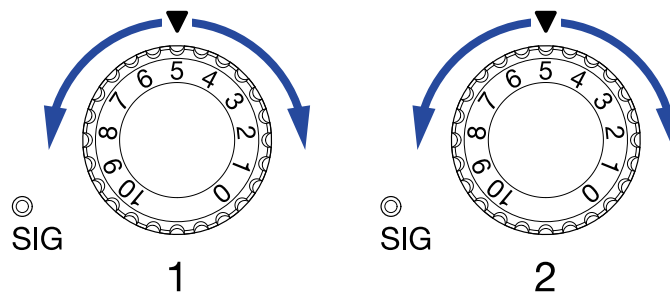



**6.** Adjust the output volume. (→ [Adjusting the volume](#))

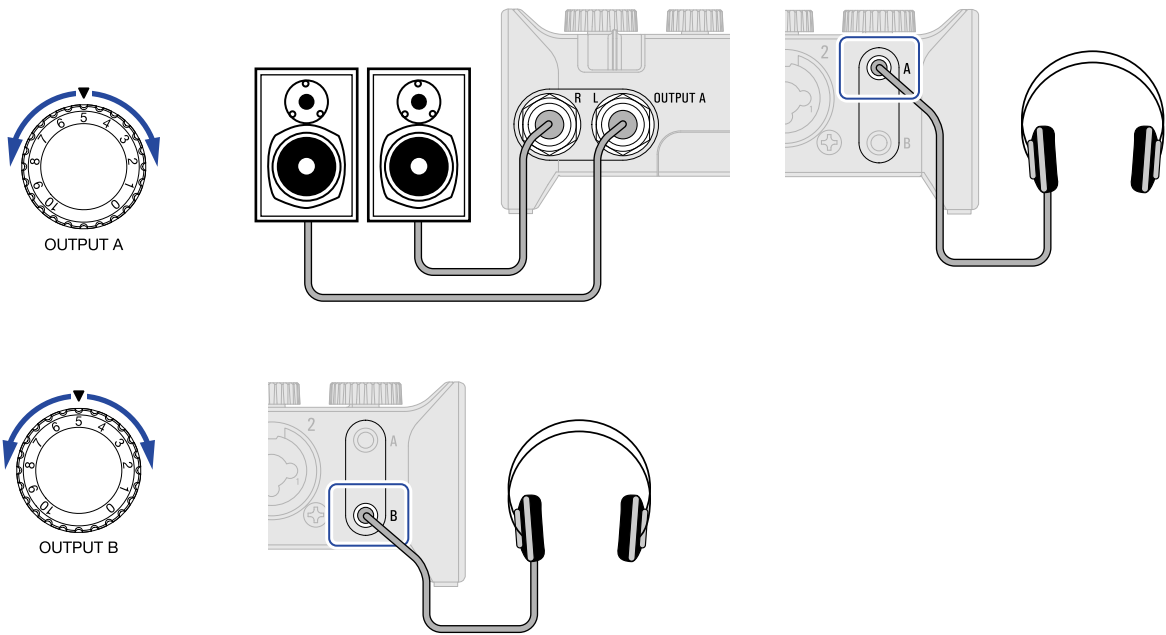

**7.** Launch the DAW app on the computer, smartphone or tablet, and select the AMS-24 as the audio interface.

**8.** Create recording tracks in the DAW app, and start recording.

**NOTE:**

Refer to the DAW app manual for how to use it.

# Use example: Web streaming using a computer

When connecting with a computer for web streaming or podcast recording, set the AMS-24 to STREAMING mode.

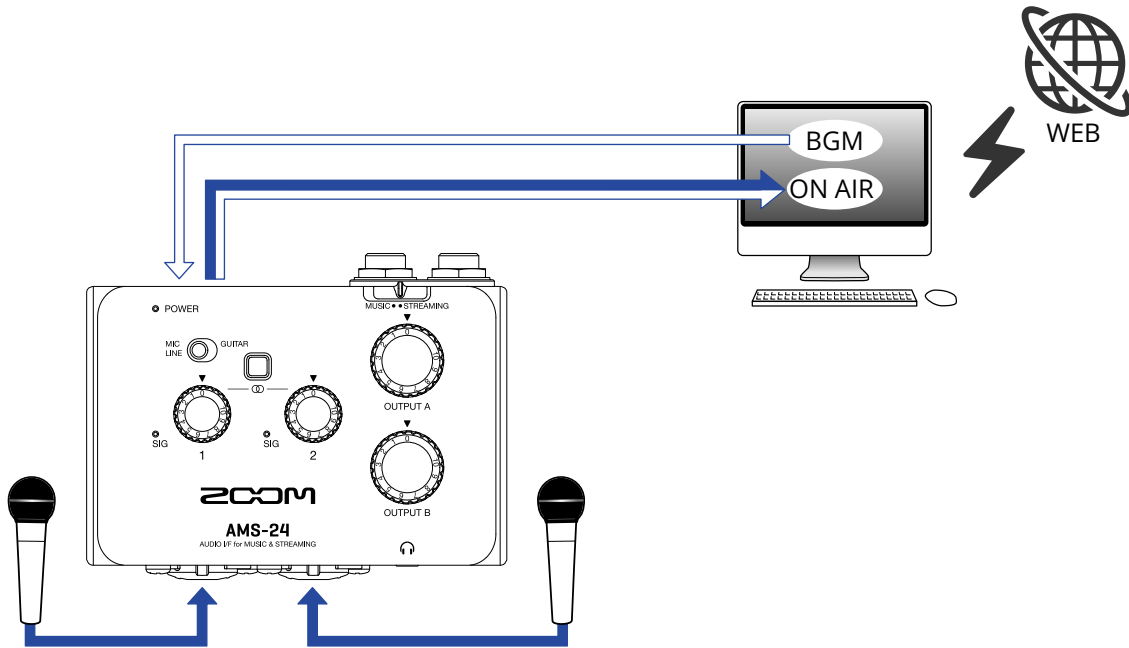

1. Set  to STREAMING mode. (→ [STREAMING mode](#))

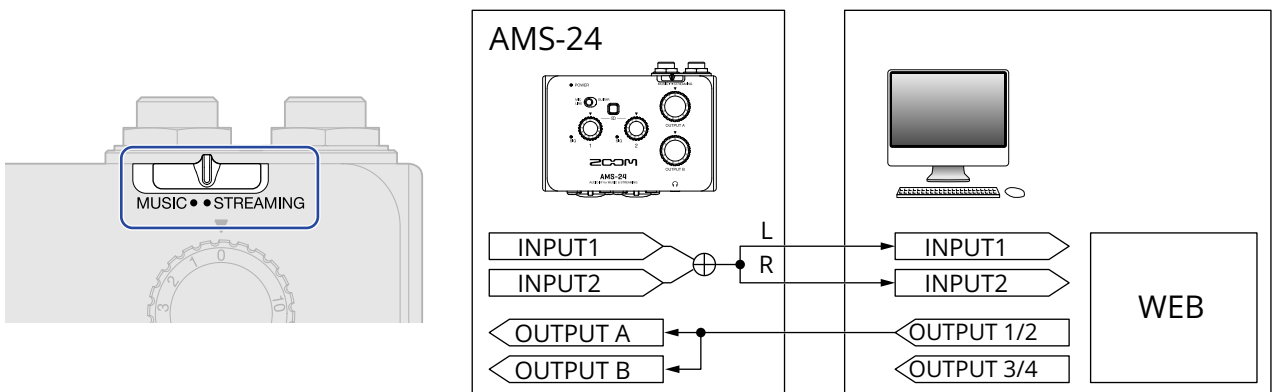

2. Connect the AMS-24 and the computer. (→ [Connecting to a computer](#))

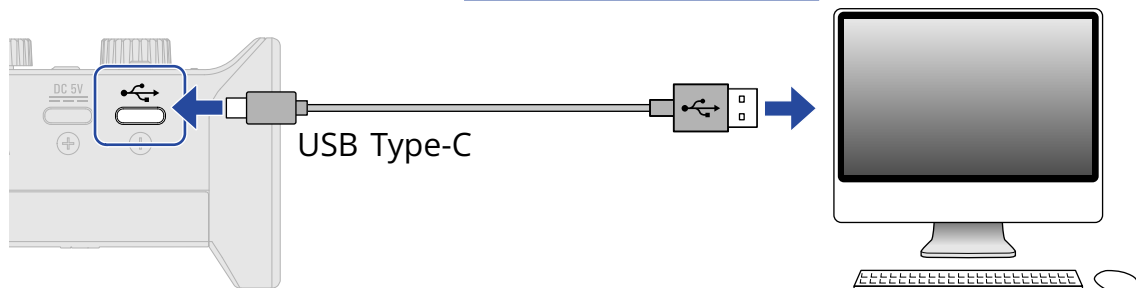

- 3.** Connect the mic and instrument and set the switches. (→ [Connecting instruments](#), [Connecting mics](#))

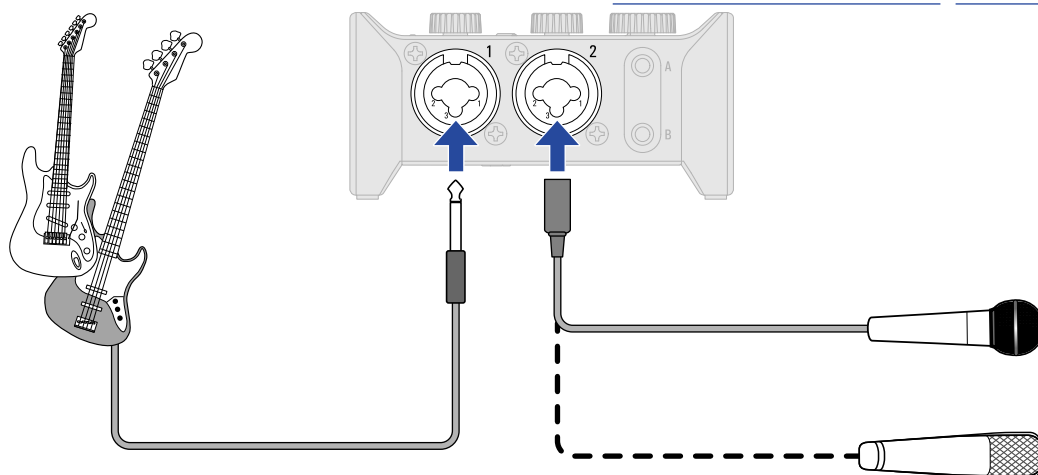

- 4.** Adjust the input gain. (→ [Adjusting the input gain](#))

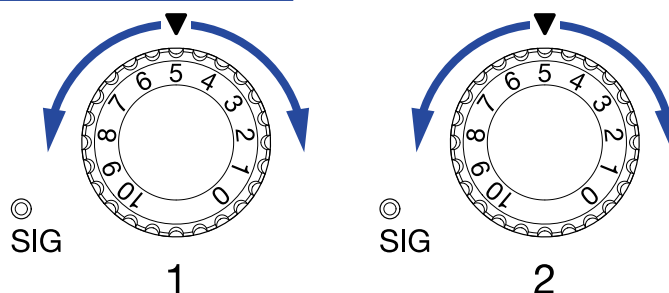

- 5.** Select the AMS-24 as the computer input and output device.

- 6.** To enable the loopback function, set  LOOPBACK OFF ON to ON. (→ [Enabling the loopback function](#))



**7.** Adjust the output volume. (→ [Adjusting the volume](#))

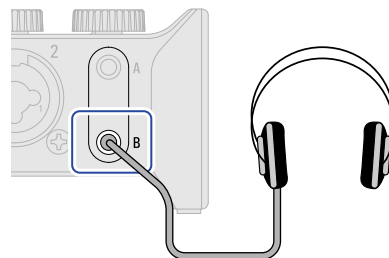
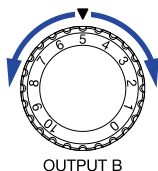
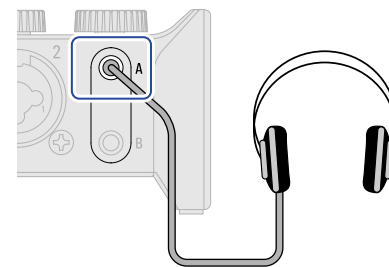
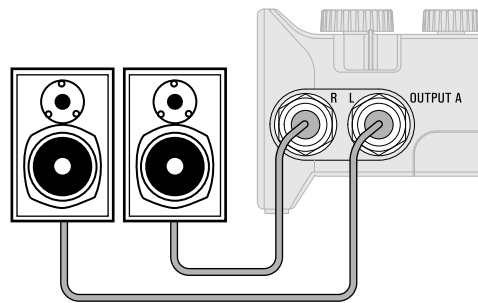
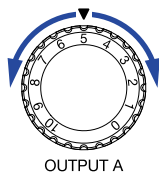

**8.** Launch the streaming app on the computer, smartphone or tablet, and select the AMS-24 as the “audio” or “input/output” device.

**9.** Start streaming.

**NOTE:**

- Use BGM with permission from its creators.
- Refer to the streaming app manual for how to use it.

# Use example: Web streaming using a smartphone/tablet

When using a smartphone/tablet for web streaming or podcast recording, set the AMS-24 to STREAMING mode.

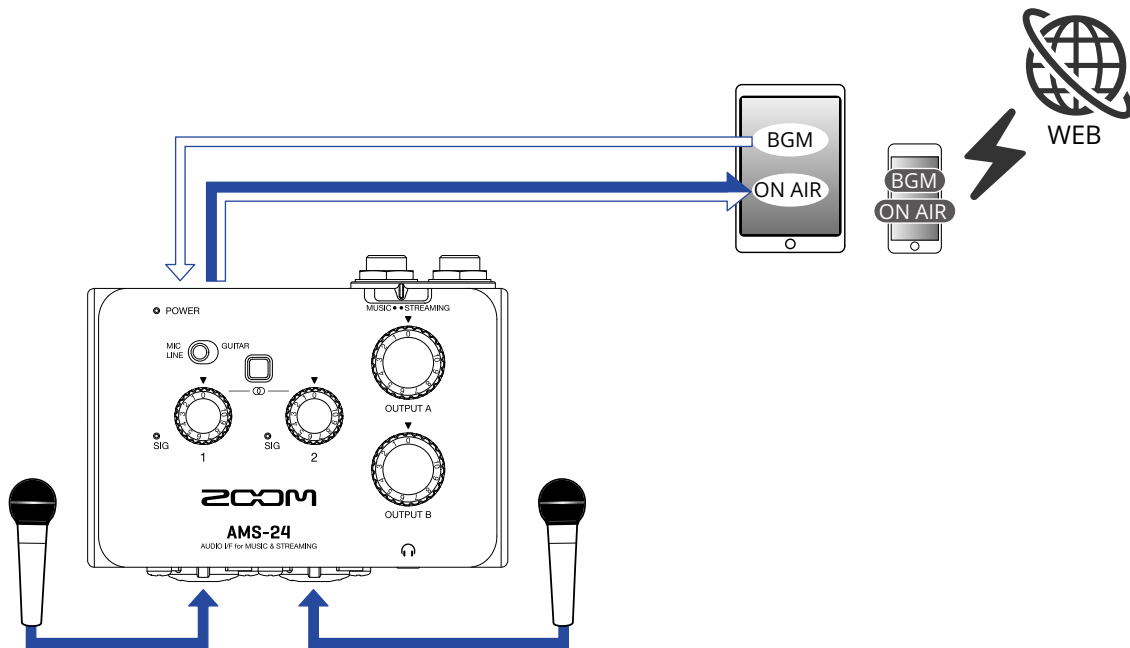

1. Set  to STREAMING mode. (→ [STREAMING mode](#))

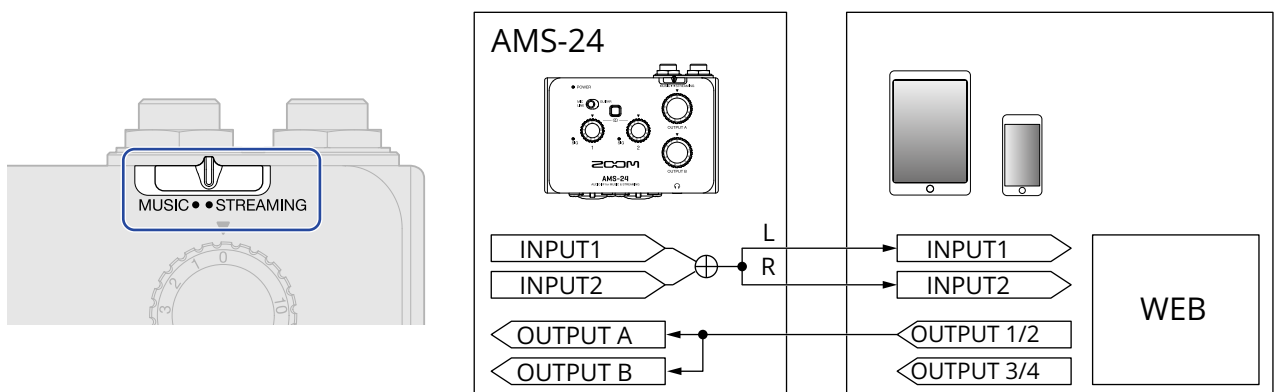

2. Supply power. (→ [Supplying power](#))

## NOTE:

Power must be provided before connecting a smartphone or tablet to the AMS-24.

**3.** Connect the AMS-24 and smartphone/tablet. (→ [Connecting smartphones and tablets](#))

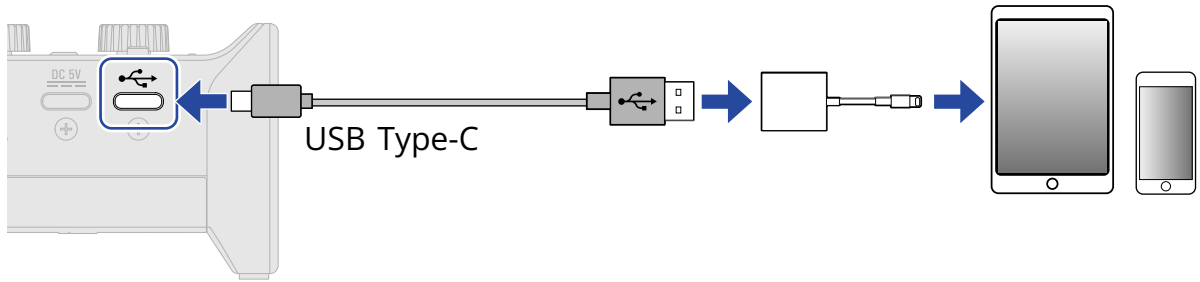

**4.** Connect the mic and instrument and set the switches. (→ [Connecting instruments](#), [Connecting mics](#))

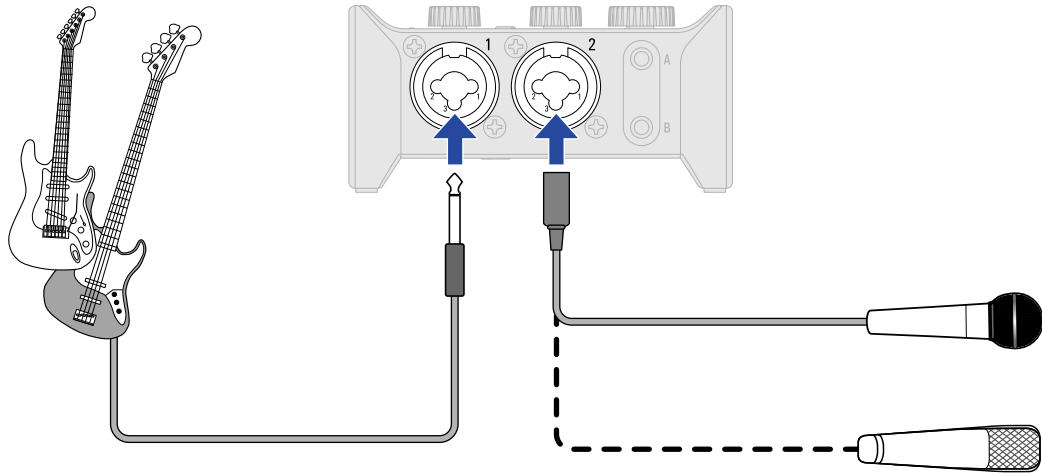

**5.** Adjust the input gain. (→ [Adjusting the input gain](#))

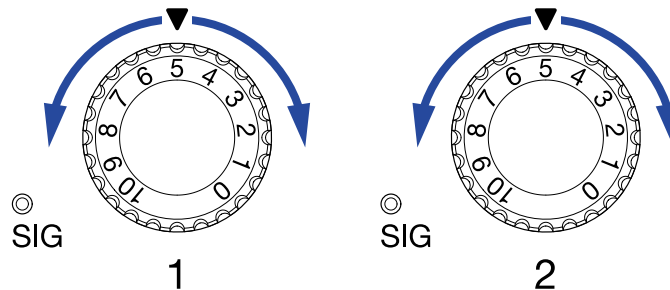

**6.** Adjust the output volume. (→ [Adjusting the volume](#))

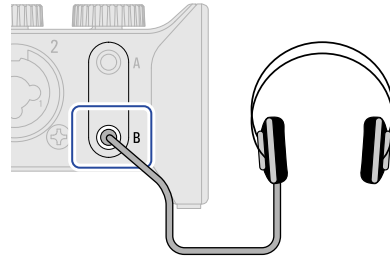
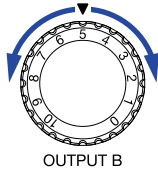
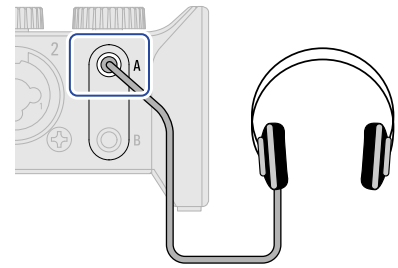
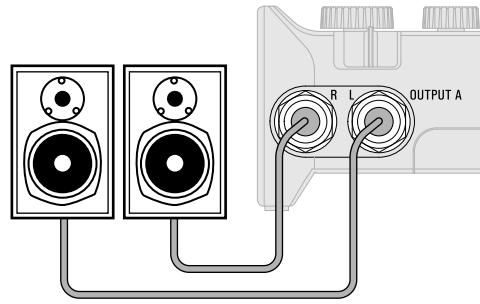
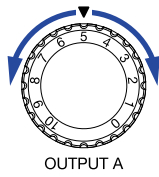

**7.** Launch the streaming app on the smartphone/tablet, and start streaming.

**NOTE:**

Refer to the streaming app manual for how to use it.

# Mixer diagram

AMS-24

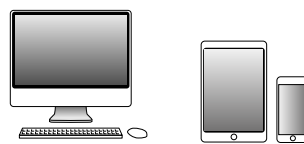
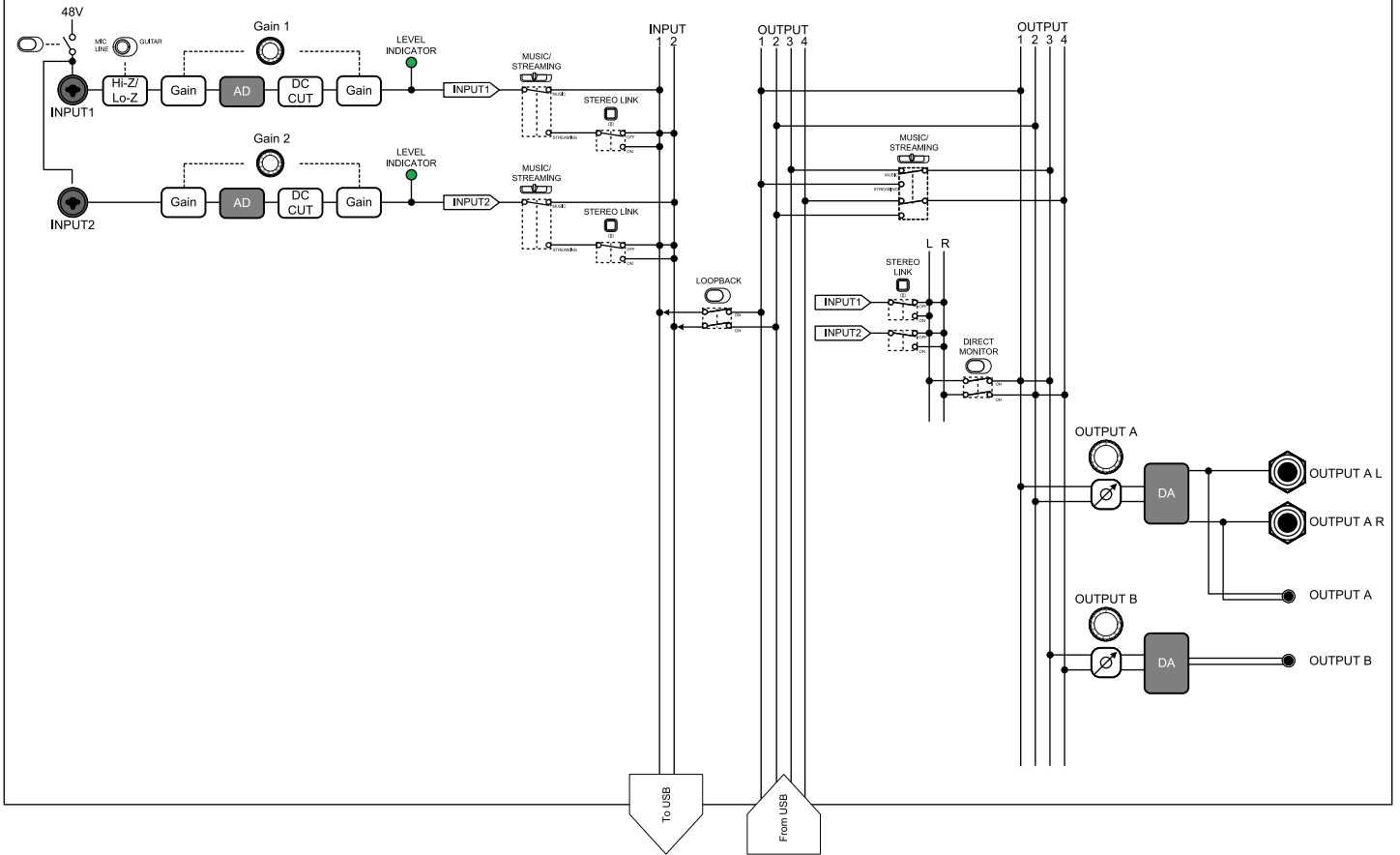



# Terms used in this manual

---

## USB audio interface

This is a device that can input sound from mics and instruments, for example, to a computer, smartphone or tablet as well as output sound from such a device to speakers and headphones.

## Dynamic mic

These mics do not require phantom power and are tough and durable.

## Condenser mic

These mics usually have high sensitivity and can capture sound with high quality. These require phantom power supply for use.

## Phantom power (48 V)

This is a function that supplies power to devices that require an external power supply, including some condenser mics.





+48 V is standard.

# Troubleshooting

## Cannot select or use the AMS-24 device

- Confirm that the AMS-24 has been connected correctly on the computer. (→ [Connecting to a computer](#))
- Quit all software that is using the AMS-24. Then, disconnect and reconnect the USB cable connected to the AMS-24.
- If using a USB hub, stop using it. Connect the AMS-24 directly to a USB port on the computer.
- When connecting to a Windows computer, installing the dedicated driver can resolve problems with applications other than DAWs. (→ [Installing the driver on Windows computers](#))
- Reinstall the dedicated driver.



## The sounds of devices connected to input jacks are distorted, too quiet or silent

- When using a condenser mic, set  48V(1-2) to ON.
- Confirm that the level indicator is not lighting red. If it is lighting red, use the  Gain knob to lower the input gain.
- Use the  Gain knob to adjust the signal level.
- Use  OUTPUT A and  OUTPUT B knobs to adjust the volume.

## Cannot play or record

- Confirm that “ZOOM AMS-24” is selected in the “Sound” setting of the computer being used.
- Confirm that AMS-24 is set for input and output in the software being used.
- Quit all software that is using the AMS-24. Then, disconnect and reconnect the USB cable connected to the AMS-24.

## Playback sound cannot be heard or is quiet

- Check the connections and volume settings of the speakers.
- Use  OUTPUT A and  OUTPUT B knobs to adjust the volume.

## Recorded audio is too loud, too quiet or silent

- Use the  Gain knobs to adjust the signal levels.

## A smartphone or tablet cannot be used

- Confirm that the external power supply is connected or that batteries are loaded correctly. (→ [Using an external power supply](#), [Using batteries](#))
- When using batteries, turn  on. (→ [Using batteries](#))

## Sound skips during playback or recording

- If the audio buffer size of the software being used can be adjusted, increase it.
- Turn off the automatic sleep function and other computer power saving settings.
- If using a USB hub, stop using it. Connect the AMS-24 directly to a USB port on the computer.

# Specifications

Input and output channels	Number of input channels	Mono (MIC/LINE)	2
	Number of output channels	Stereo (TRS)	1
		Stereo (PHONES)	2
Connectors	Input 1-2	Type	XLR/TRS combo jacks (XLR: 2 HOT, TRS: TIP HOT)
		Input gain	$-\infty$ – +58 dB / $-\infty$ – +50 dB (when set to GUITAR)
		Input impedance	XLR: 2.7 k $\Omega$ TRS: 18 k $\Omega$ / 330 k $\Omega$ (when set to GUITAR)
		Maximum input level	XLR: +6 dBu TRS: +22 dBu / +8.5 dBu (when set to GUITAR)
		Phantom	+48 V
		OUTPUT A (standard phone jacks)	Type
	Maximum output level		+10 dBu (at 0 dBFS)
	Output impedance		100 $\Omega$
	OUTPUT A-B (headphone jacks)	Type	3.5mm stereo mini jacks 30 mW + 30 mW (32 $\Omega$ load)
		Output impedance	10 $\Omega$
	USB		USB Type-C (audio interface function) • Use a USB cable that supports data transfer. USB bus power is supported.
	DC 5V		USB Type-C (for power supply)
Frequency response		44.1 kHz: $\pm 1$ dB (20 Hz – 20 kHz) 96 kHz: $\pm 1.5$ dB (20 Hz – 40 kHz)	
Equivalent input noise		–120 dBu or less (IHF-A) at +58dB/150 $\Omega$ input	
Audio interface	Input and output channels	Recording: 2 channels Playback: 4 channels	
	Sampling frequencies	96 kHz, 88.2 kHz, 48 kHz, 44.1 kHz	

	Bit depth	24-bit
	Interface	USB 2.0
	Class	USB Audio Class 2.0
Power		2 AA batteries (alkaline, lithium, or rechargeable NiMH) AC adapter (ZOOM AD-17): DC 5 V/1 A • USB bus power is supported.
Rated current		USB/AC adapter (5 V): 380 mA --- Batteries (2.4 V): 470 mA ---
Estimated continuous operation time using batteries		44.1 kHz, 48 V off, with 32Ω headphone load Alkaline batteries: about 4 hours NiMH batteries (1900 mAh): about 5.5 hours Lithium batteries: about 11 hours • The above values are approximate. • Continuous battery operation times were determined using in-house testing methods. They could vary greatly according to use conditions.
Power consumption		5 W maximum
Dimensions		94.5 mm (W) × 74.0 mm (D) × 46.0 mm (H)
Weight (unit only)		134 g
Weight (including batteries)		180 g

Note: 0 dBu = 0.775 Vrms



ZOOM CORPORATION

4-4-3 Kanda-surugadai, Chiyoda-ku, Tokyo 101-0062 Japan

[zoomcorp.com](https://zoomcorp.com)