



FT17H

Features

- High cost performance horn tweeter
- Well extended high frequency, 5kHz to 50kHz
- Shielded magnet circuit is employed

Specifications

&

Thiele/Small Parameters

Impedance	: 8 Ω
Reproduction Frequency Response	: 5 kHz - 50 kHz
S.P.L.	: 98.5 dB/W(m)
Power Handling	: 30 W (music)
Cutoff Frequency	: 2.6 kHz
Recommended Crossover Frequency	: 5 kHz or more
Magnet Weight	: 113.5 g / 0.25 lb
Net Weight	: 340 g / 0.75 lb



Frequency Response / Impedance

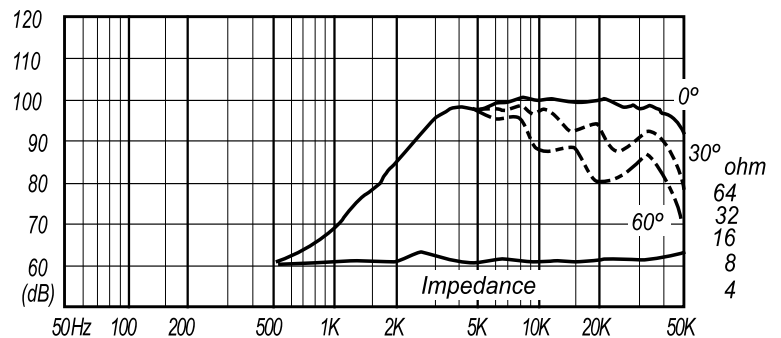

Configuration Example

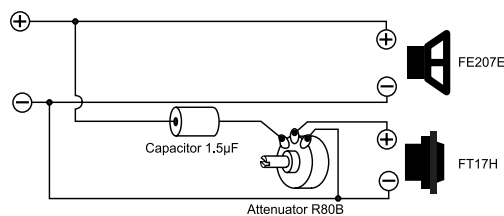

Dimensions & Mounting Information

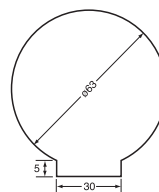
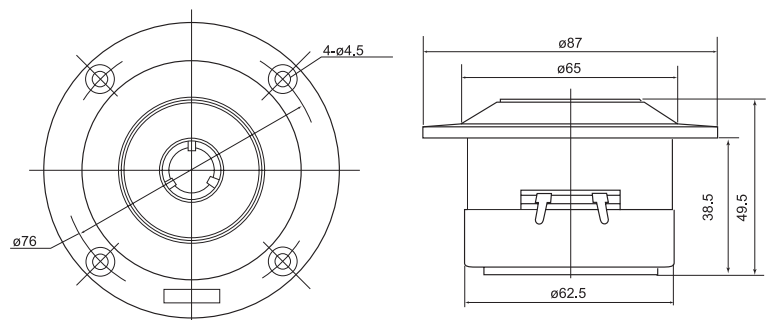

Overall Diameter	: 87 mm / 3.5 in
Baffle Hole Diameter	: 63 mm / 2.4 in
Depth	: 49.5 mm / 1.9 in